

MVP Patriot Systems

Operations Manual

Models:

- FIT-C-HVPAT
- FIT-C-PAT
- FIT-W-HVPAT
- FIT-W-PAT
- IMC-HVPAT
- IMC-PAT
- IMG-PAT
- IMW-HVPAT
- IMW-PAT
- MCS-PAT
- MGS-PAT
- MWS-PAT
- SF-FIT-C-PAT
- SF-FIT-G-PAT
- SF-FIT-W-PAT

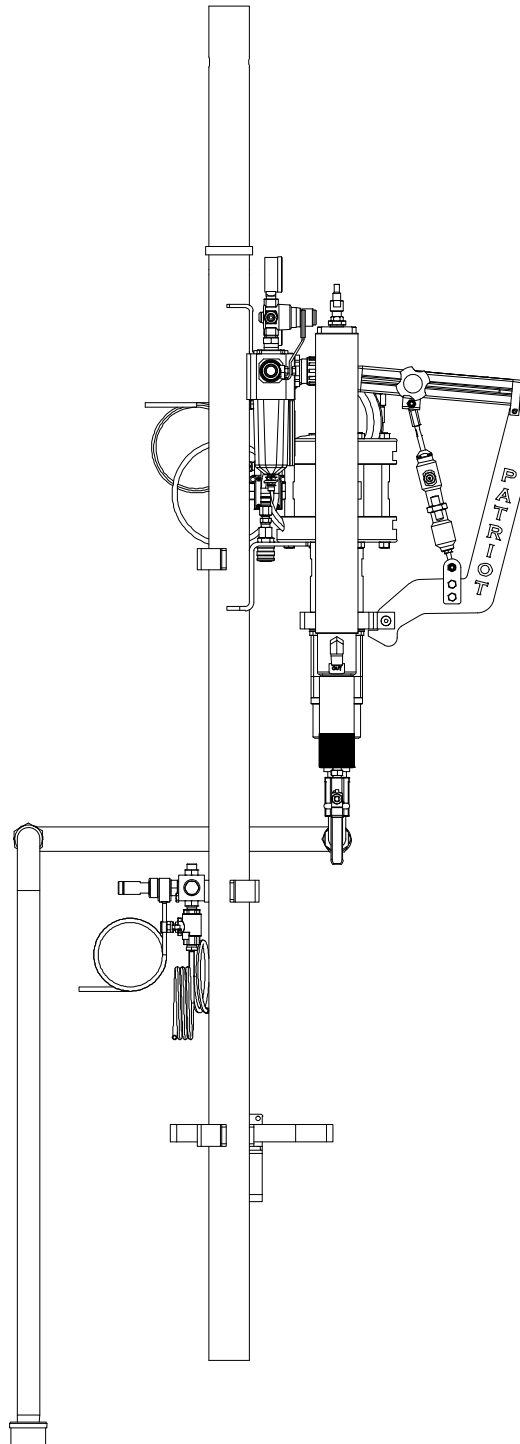

Contents

Warnings	3
Introduction	8
Getting Started	11
Priming the Unit	13
Establishing a Spray Fan	14
Spray Testing	18
Start-Up & Shut-Down : Internal Mix	23
Start-Up & Shut-Down : External Mix	27
Gun Hose Connections	31
Maintenance	32
Troubleshooting	33
Troubleshooting for AT Guns	37
Catalyst Pump - Air Lock	38
System Components	39
Warranty	57
Contact	59

Warnings

Due to the vast number of chemicals that could be used and their varying chemical reactions, the buyer and user of this equipment should determine all factors relating to the fluids used, including any of the potential hazards involved. Particular inquiry and investigation should be made into potential dangers relating to toxic fumes, fires, explosions, reaction times, and exposure of human beings to the individual components or their resultant mixtures. MVP assumes no responsibility for loss, damage, expense or claims for bodily injury or property damage, direct or consequential, arising from the use of such chemical components.

The end user is responsible for ensuring that the end product or system complies with all the relevant laws in the country where it is to be used and that all documentation is adhered to.

Recommend Occupational Safety & Health Act (OSHA) Documentation:

- 1910.94 Pertaining to Ventilation.
- 1910.106 Pertaining to flammable liquids
- 1910.107 Pertaining to spray finishing operations, particularly Paragraph (m) Organic Peroxides and Dual Component Coatings.

For Additional information, contact the Occupational Safety and Health Administration (OSHA).

<https://www.osha.gov/about.html>

Recommended National Fire Protection Association (NFPA) Documentation:

- NFPA No.33 Chapter 14, Organic Peroxides and Dual Component Materials
- NFPA No.63 Dust Explosion Prevention
- NFPA No.70 National Electrical Code
- NFPA No.77 Static Electricity
- NFPA No.91 Blower and Exhaust System
- NFPA No.654 Plastics Industry Dust Hazards

* **Fire Extinguisher** – code ABC, rating number 4a60bc using Extinguishing Media – Foam, Carbon Dioxide, Dry Chemical, Water Fog, is recommended for this product and applications.

Please contact your nearest MVP Technical Service Representative if additional information is needed.

Safety Precautions

- Avoid skin contact and inhalation of all chemicals.
- Review MSDS with personnel to promote the safe handling of chemicals in use.
- Restrict the use of all chemicals to designated areas with good ventilation.
- Chemicals are Flammable and reactive.
- Noxious fumes released when combusted.
- Operate equipment in a ventilated environment only.
- Uncured liquid resins are highly flammable unless specifically labeled otherwise.
- Cured laminate, accumulations of over spray, and laminate sandings are highly combustible.
- Do not operate or move electrical equipment when flammable fumes are present.
- Ground all equipment.
- If a spark is seen or felt, immediately halt operation. Do not operate the equipment until the issue has been identified and repaired.
- Contaminated catalyst may cause Fire or Explosion.
- Containers may explode if exposed to fire / heat.
- Use and store chemicals away from heat, flames, and sparks.
- Do not smoke in work areas or near stored chemicals.
- Do not mix MEKP with materials other than polyethylene.
- Do not dilute MEKP.
- Keep food and drink away from work area.



Physical Hazards

- Never look directly into the spray gun fluid tip. Serious injury or death can result.
- Never aim the spray gun at or near another person. Serious injury or death can result.
- Inhalation, Ingestion, or injection may damage internal organs and lead to pulmonary disorders, cancers, lymphomas, and other diseases or health conditions.
- Other potential health effects include: irritation of the eyes and upper respiratory tract, headache, light-headedness, dizziness, confusion, drowsiness, nausea, vomiting, and occasionally abdominal pain.
- Chemical compounds can be severely irritating to the eyes and skin.
- **Eye contact:** Immediately flush with water for at least 15 minutes, and seek immediate medical attention.
- **Skin Contact:** immediately wash with soap and water, and seek immediate medical attention.
- **Inhalation:** Move the person to fresh air, and seek immediate medical attention.
- Do not remove shields, covers, or safety features on equipment that is in use.
- Never place fingers, hands, or any body part near or directly in front of the spray gun fluid tip. The force of the liquid as it exits the spray tip can shoot liquid through the skin.
- Keep hands and body parts away from any moving equipment or components



Personal Protective Equipment (PPE)

- MVP recommends the use of personal safety equipment with all products in our catalog.
- Wear safety glasses or goggles, a respirator, and chemical resistant gloves.
- Wear long sleeve shirts or jackets and pants to minimize skin exposure.
- PPE should be worn by operators and service technicians to reduce the risk of injury.



Polymer Matrix Materials: Advanced Composites

Potential health hazards associated with the use of advanced composites can be controlled through the implementation of an effective industrial hygiene and safety program.

https://www.osha.gov/dts/osta/otm/otm_iii/otm_iii_1.html#t_iii:1_1

Composite Component	Organ system target (possible target)	Known (possible) health effect
Resins		
Epoxy resins	Skin, lungs, eyes	Contact and allergic dermatitis, conjunctivitis
Polyurethane resins	Lungs, skin, eyes	Respiratory sensitization, contact dermatitis, conjunctivitis
Phenol formaldehyde	Skin, lungs, eyes	As above (potential carcinogen)
Bismaleimides (BMI)	Skin, lungs, eyes	As above (potential carcinogen)
Polyamides	Skin, lungs, eyes	As above (potential carcinogen)
Reinforcing materials		
Aramid fibers	Skin (lungs)	Skin and respiratory irritation, contact dermatitis (chronic interstitial lung disease)
Carbon/graphite fibers	Skin (lungs)	As noted for aramid fibers
Glass fibers (continuous filament)	Skin (lungs)	As noted for aramid fibers
Hardeners and curing agents		
Diaminodiphenylsulfone	N/A	No known effects with workplace exposure
Methylenedianiline	Liver, skin	Hepatotoxicity, suspect human carcinogen
Other aromatic amines		
Meta-phenylenediamine (MPDA)	Liver, skin (kidney, bladder)	Hepatitis, contact dermatitis (kidney and bladder cancer)
Aliphatic and cyclo-aliphatic amines	Eyes, skin	Severe irritation, contact dermatitis
Polyaminoamide	Eyes, skin	Irritation (sensitization)
Anhydride	Eyes, lungs, skin	Severe eye and skin irritation, respiratory sensitization, contact dermatitis

Emergency Stop Procedure:

In an emergency, perform the steps below to stop an MVP Patriot System.

1. Locate the slide valve where the air enters the power head of the resin pump.
2. Turn all system regulators to the “OFF” position (counter-clockwise) position.
3. Verify / secure the Catalyst relief line, located on the catalyst relief valve.
4. Verify / secure the Resin return line, located on the resin filter
5. Place a container under the Resin pump ball valve to catch ejected resin.
6. Locate the ball valve on the Resin pump.
7. Rotate the ball valve 90 degrees to the “On” or open position.

Note: The “open” or “on” position is when the ball valve handle is parallel (in line) with the ball valve body. The “closed” or “off” position is when the ball valve handle is perpendicular (across) the ball valve body.

Grounding:

Grounding an object means providing an adequate path for the flow of the electrical charge from the object to the ground. An adequate path is one that permits charge to flow from the object fast enough that it will not accumulate to the extent that a spark can be formed. It is not possible to define exactly what will be an adequate path under all conditions since it depends on many variables. In any event, the grounding means should have the lowest possible electrical resistance.

Grounding straps should be installed on all loose conductive objects in the spraying area. This includes material containers and equipment. Magnum Venus Products recommends grounding straps be made of AWG No.18 stranded wire as a minimum and the larger wire be used where possible. NFPA Bulletin No77 states that the electrical resistance of such a leakage path may be as low as 1 meg ohm (10 ohms) but that resistance as high as 10,000 meg ohms will produce an adequate leakage path in some cases. Whenever flammable or combustible liquids are transferred from one container to another, or from one container to the equipment, both containers or container and equipment shall be effectively bonded and grounded to dissipate static electricity. For further information, see National Fire Protection Association (NFPA) 77, titled “Recommended Practice on Static Electrical”. Refer especially to section 7-7 titled “Spray Application of Flammable and Combustible Materials”.

Introduction

This manual provides information needed to properly operate and perform simple maintenance and repair on this equipment.

- Step-by-step operations procedures are provided.
- This manual includes Installation, Start-up and Shut-Down instructions.

Please read the manual carefully. Follow the steps in the order given, otherwise you may damage the equipment or injure yourself.

Major Components:

Patriot Systems consist of the following major components:

- Gel Pump Fluid section and Air Motor.
- Shift Block Assembly.
- Catalyst Pump Assembly
- Gun Assembly

Description of Controls for Spray unit:

Familiarize yourself with the Air Manifold controls, which consist of the following regulators and gauges:

- PUMP PRESSURE gauge and regulator. This controls the main air pressure to the Gel pump Air Motor.
- ATOMIZING-AIR gauge and regulator. This controls the air pressure to the catalyst nozzle on the gun. This is normally set to 18 – 25psi (1 -1.5 bar)
- Gel DUMP VALVE – This located at the bottom of the Filter Body. This is used to relieve gel coat pressure.

Pump Design:

MVP has a variety of pumps in a wide range of configurations. Most of the pumping systems are based on a “double acting piston pump”. Double acting piston pumps are a two ball style pump which delivers material on both the up and down stroke. They are driven by an air motor of which there are a variety of sizes. There are three basic resin pump sizes; Gel coat – lower output systems, gel coat application, Chopper / Standard – mid range output, most commonly used for chopper and wet out systems and High Volume – high volume chopper systems and special or automatic equipment.

Pump Design: Down stroke

DOWN STROKE: The down stroke is the displacement stroke, meaning the material in the inlet body is displaced by the piston and forced out the pump. The inlet valve ball seats sealing the inlet body this forces the material to flow up and out of the pump. The piston body ball lifts off its seat and allows material to flow through the piston and out the pump.

Piston body ball lifts off its seat allowing material to flow out the pump

Inlet body ball seats sealing off the pump cylinder forcing material thru the piston body and out the pump.

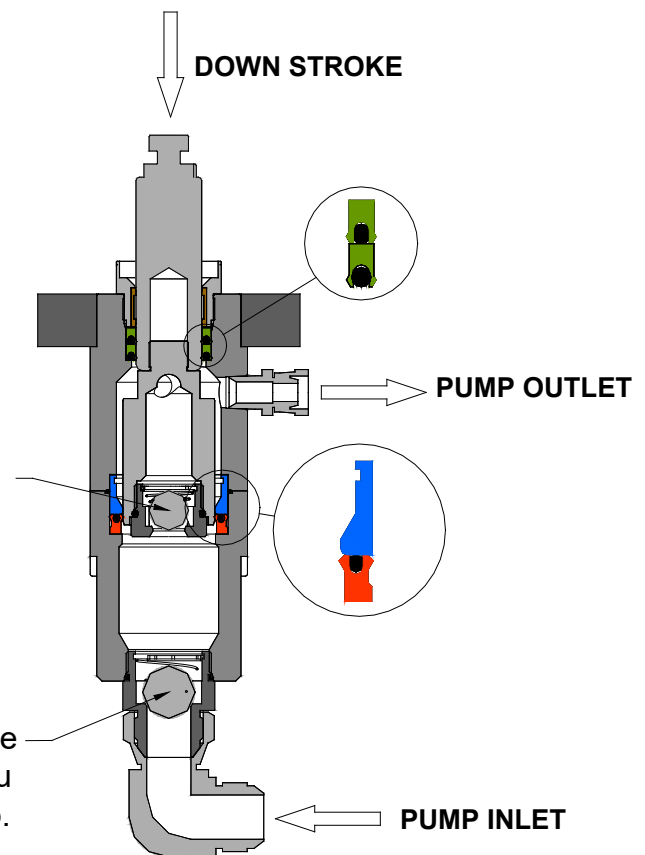

Pump Design: Up stroke

UP STROKE: The piston seal seals on the piston, the piston body ball seals in its seat; everything above the piston body is pushed out. A vacuum is created below the piston body and new material is drawn in.

Piston body ball seals forcing all the material above the piston out of the pump

Inlet valve ball lifts from its seat and new material is drawn into the pump inlet body.

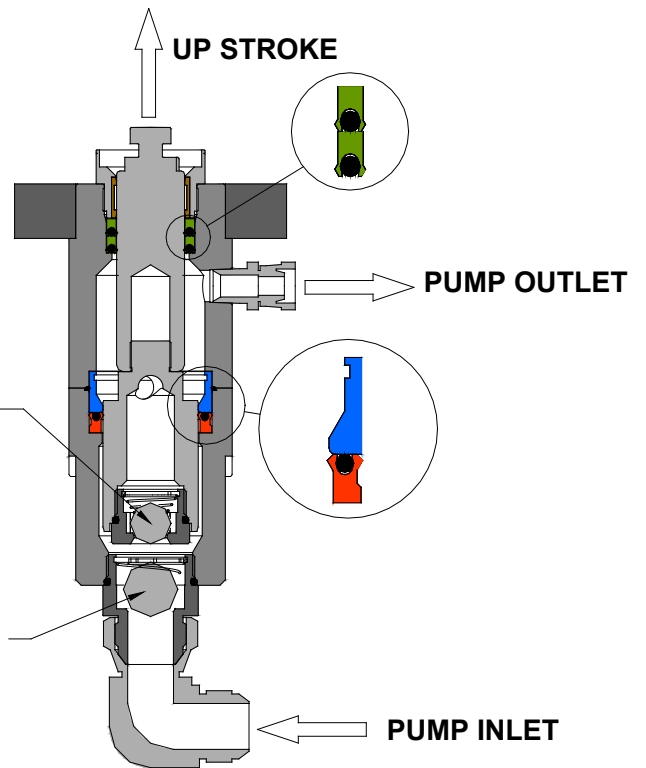

Getting Started

Air Requirements:

Clean, dry compressed air must be available at 90 – 100 psi (6 – 7 bar) and a minimum volume of 10 CFM (0.3 m³). Air must be provided through an air hose with a diameter of 0.5 inch (1.3 cm) or greater.

Lubrication:

Throughout this manual, directions are given for lubricating various parts of the Patriot System. There are three types of lubricant used:

- If the part contacts resin, use MVP Red Grease (6706-2-1).
- If the part is located where it will contact air, use Lubriplate® (08465).
- PAT-LS-OIL is used in the oil reservoir of the pump.

Other Supplies:

- Solvent for cleaning.
- A small chip / paint brush for cleaning.
- Small cup or container for the solvent.
- Wet gel gauge to determine gel coat thickness.

Installation and Setup:

1. Unpack unit & components – report any damaged or missing items.
2. Assemble unit – mount Pump to the cart, install Catalyst Pump onto the Slave Arms.
3. Install Catalyst Jug into the Catalyst jug bracket.
4. Connect the Relief Valve tube to the top port in the Catalyst Jug.
5. Connect the Feed tube from the Catalyst jug outlet to the Catalyst pump Inlet.
6. Connect the Catalyst hose to the Catalyst Pump outlet.
7. Install Gel coat Filter & Surge Chamber assembly.
8. Attach the Gel coat hose to the Outlet of the Filter assembly.
9. Install Air Manifold - connect Air Hose to Powerhead & Air Supply to the Shift Block.
10. Attach hose fittings, catalyst atomizing hose and gun air supply.
11. Attach Pickup Hoses to the Inlet of the pump.
12. Double check all hose fittings and connections are tight.

Note: It is important to be sure all fittings and connections are tight to prevent catalyst or gel coat leaking.

Priming the Unit

Priming Gel Coat to Gun:

Note: *The resin pump was tested using oil. It may require up to 1/2 gallon (1 – 2 liters) of gel coat to be run through the unit to purge any remaining oil from the system.*

1. Fill the Reservoir cavity 1/2 full with PAT-LS-OIL or suitable oil.
2. Insert the gel coat suction wand into container of gel coat. Clamp or tape the return hose coming from the bottom of the in-line filter to the pickup wand and into the drum / pail.
3. Remove the Catalyst Tip and Spray Tip from the front of the gel coat gun.
4. Position the gun over an appropriate container and with the gun trigger locked in the open position, slowly increase pump regulator pressure until pump is running at a slow but steady rate. Allow pump to run until a steady stream of gel coat is being dispensed.
5. Close the gun and brush the front of the gun head clean with solvent.
6. Slowly increase gel coat pump pressure to 100 psi (7 bar). Allow the unit to set under static load for 15 to 30 minutes to seat the resin packing set.
7. Turn the pump regulator to zero. Slowly open the ball valve at the bottom of the resin filter to drain the fluid pressure

Priming Catalyst to Gun:

1. Remove the catalyst tip and spray tip from the front of the gun.
2. Tighten the catalyst packing nut – 1/8 to 1/4 of a turn to snug packing.
3. Fill the catalyst jug ¾ full, purge the air out of the catalyst feed line by slightly tilting the catalyst jug toward the outlet fitting.
4. Lock or hold the gun trigger in the open position over an appropriate container.
5. Remove the pin from the slave arm and catalyst pump bearing block. Use the priming knob to hand prime catalyst out to the gun until a steady stream is achieved.
6. Release the trigger to close the gun.
7. Replace the pin into the slave arm and catalyst pump bearing block – be sure that the catalyst pump is positioned at the correct percentage.

Note: *Be sure the top and bottom of the catalyst pump are set to the same percentage on the slave arm to prevent damage to the catalyst pump.*

Establishing a Spray Fan

Gun Set-Up

Note: Use a little red grease on the o-rings and threads before installing the spray tip, catalyst tip and retaining ring.

1. Install the Gel Coat Spray Tip into the front of the gun block.
2. Install the Catalyst Tip over the Spray Tip. Use caution not to damage the o-rings on the front of the gun block.
3. Install the retaining ring to secure Catalyst Tip and Spray Tip in place.

Establishing a Fan Pattern

Magnum Venus Products spray equipment provides one of the most efficient methods of quickly applying material to a surface or mold. To make the most of our low-pressure pumping systems and airless, internal mix guns, the operator must understand how to adjust the system for maximum efficiency.

Note: Because conditions and material vary widely, we cannot give you specific instructions. We do offer guidelines and tests so that you can tune your Magnum Venus Products equipment to meet your needs.

The basic idea is to use just enough pressure to the power head to establish the spray fan, and no more.

1. Lay out a strip of material for the test. For testing the material can be paper or cardboard.
2. Adjust the main pressure regulator until the operating pressure is 20psi.

Note: Operating Pressure is the air pressure used to operate the resin/catalyst pump. The gauge and regulator are usually labeled "Main Pressure" or "Pump Pressure".

3. Do a short test spray on the material.

Note: To save material and make identification easier, spray perpendicular (across the material strip) tests.

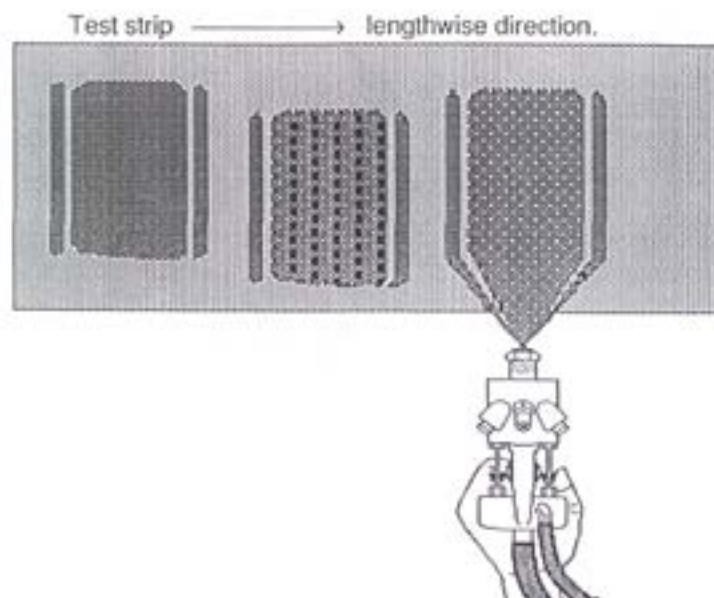

4. Flush the gun into an appropriate container after every test shot.

Note: It is unlikely that 20psi will be adequate pressure to establish a fan pattern.

5. If the first test shot had an established fan pattern, back off 5psi and shoot another pattern. Keep backing the pressure off until the unit no longer produces a fan. Then increase the operating pressure until there is just enough to form a soft-looking spray fan.
6. If the pressure was not adequate to form a well-defined fan pattern, increase the main pressure by 5psi and do another short test spray. Repeat step 6 until a well-defined spray pattern has been obtained, then follow step 5.

Adjusting a Fan Pattern

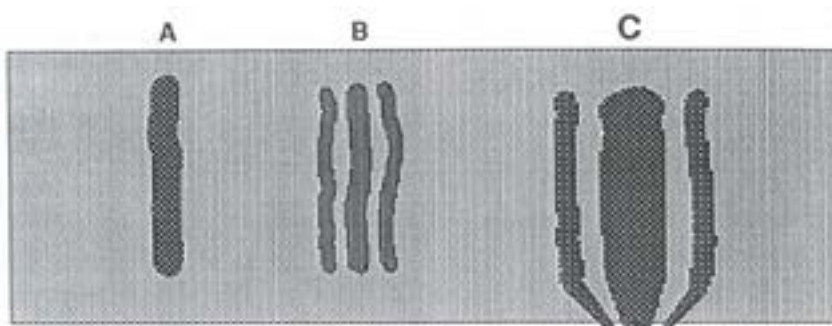

A. One narrow stream: The operating pressure is very low for the material you are using.

Solutions:

- Increase the operating pressure.
- Increase the material's temperature
- Use a smaller Nozzle size.

B. Three heavy fingers: Horns are beginning to develop, but the operating pressure is still very low.

Solutions:

- Increase operating pressure.
- Increase material's temperature.
- Use smaller nozzle size.

C. Middle of the stream is wider: but not the full width it should be for the nozzle.

Solutions:

- Increase operating pressure.
- Increase material's temperature.

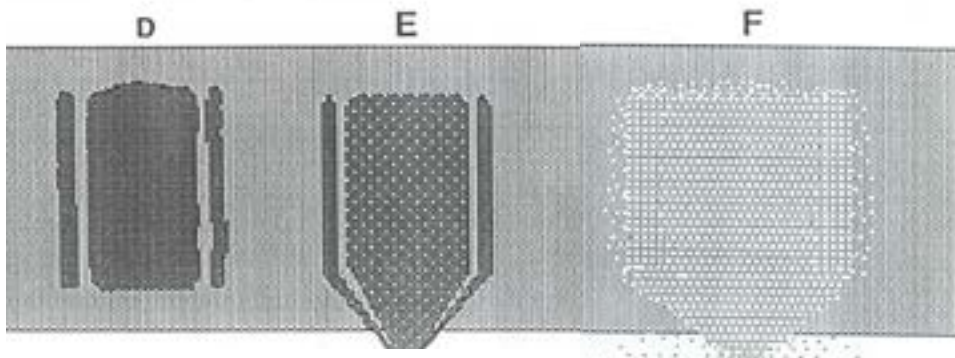

D. The pattern is at or near full width: There are well-defined fingers; however there is little or no white frothing (air bubbles) in the center of the sprayed material. Result “D” is a usable pattern for an experienced operator.

Solutions:

- Slightly increase operating pressure.
- Slightly increase material’s temperature.

E. The pattern is full width: The fingers are well-defined. A small amount of frothing appears in the sprayed material; however it should disappear in less than 2 minutes.

Note: *This is considered the best general set of conditions for the fan pattern. Make written notes of the main pressure and the material temperature readings.*

F. The pattern is too wide: and the fingers are poorly defined. Heavy misting is seen and smelled, and there is significant overspray (material laid down beyond the main pattern). The heavy white frothing does not disappear within 2 minutes.

Note: *This is the most common mistake in running Magnum Venus Products equipment.*

Solution:

- Back off the pressure until the fan pattern fails, then add 5 psi or so to get the fan pattern back.

Spray Fan Test Notes

Material(s) being used: _____

Catalyst Percentage: _____%

Catalyst type: _____

Material is being: Sprayed Poured

Other: _____

This material was successfully applied under the following conditions:

Winter Spring Summer Fall

Air temperature of the factory _____ degrees

Relative humidity of the factory _____ %

Other conditions: _____

Power head pressure _____ psi

Catalyst Accumulator charge _____ psi

Resin Accumulator charge _____ psi

In-line Heater setting _____

Nozzle size _____

Nozzle Fan Angle _____ degrees

Spray Testing

Spray tests are used to fine-tune the adjustments on your Magnum Venus Products dispensing equipment and to check the condition of your hardware and materials. Turn the chopper air pressure to zero, do the spray test without chop.

Note: Using a Color-Reactive material (materials that change color when they are catalyzed) make this testing easier and more accurate. MVP recommends using a dyed catalyst or a color-reactive material.

1. Lay a sheet of test material on a flat surface.

Note: The temperature of the surface can affect the reaction time of many chemicals. The coldness of a concrete floor can cause changes in cure times.

2. Pull the trigger and start spraying material along the test strip.

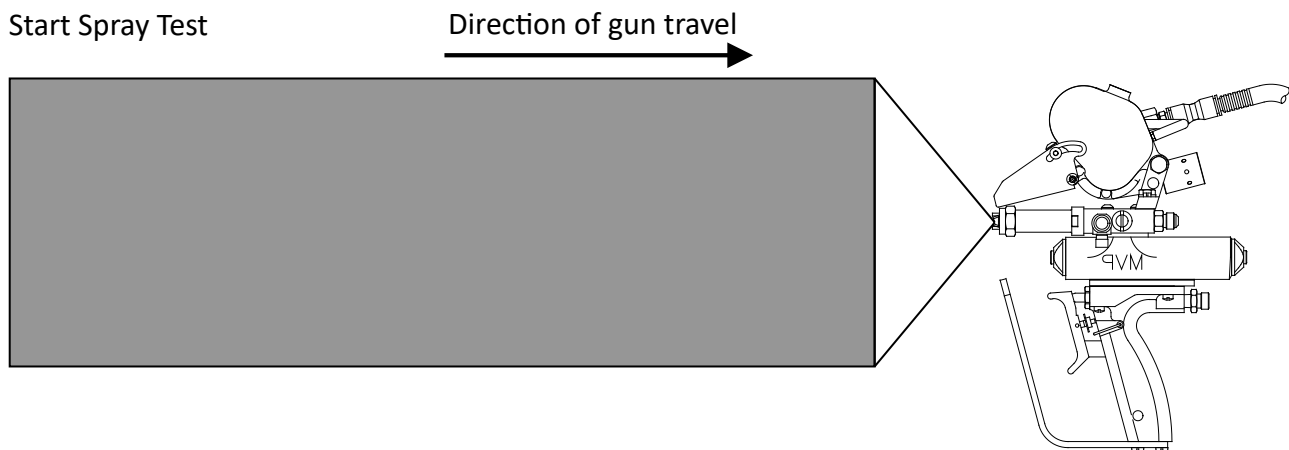

3. When you hear the pump reverse direction, have an assistant mark the spot on the test strip and indicate whether the pump was at the top "T" or the bottom "B" of the stroke.

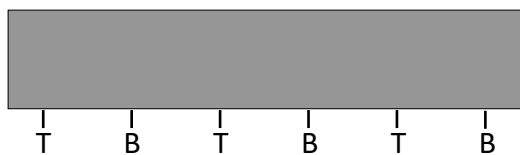

4. Continue spraying for four or five complete pump cycles with an assistant marking the test strip every time the pump gets to the top or bottom of the stroke. Your completed test strip should look something like the figure above.
5. Use a tongue depressor to test several areas on the strip: top of stroke, bottom of stroke, and the up- and down-stroke in several places. Repeat testing for material hardening several times to find out if some areas are hardening faster or slower than other areas.

Note: Color-reactive materials (materials that change color when they harden) make this testing very easy and accurate. Magnum Venus Products recommends using color-reactive materials whenever possible.

6. Make written notes directly on the test strip to show what happened. Pay particular attention to areas that harden faster or slower than other areas because that indicates a problem.

Interperting Test Results

If all areas of the test spray harden at the same time, there is no problem and you may go on to part production.

If there are areas with little or no hardening (or extremely fast hardening) check the following descriptions for the one that best matches your results and follow the suggested procedure to fix the problem: A rule of thumb is when you have slow or no cure it is a catalyst pump problem and if you have a hot spot or fast cure the problem is the resin pump. Fast cure can be the product of higher temperatures if it is over the whole part and consistent.

The tests performed below can also be adapted to pour applications by pouring a saw tooth shaped bead of material. Where the top of the saw tooth is the top of the stroke and the valley is the bottom of the stroke.

Result 1:

Material delivered at the top and bottom of the stroke is not curing or curing more slowly than the material delivered in the middle of the up- and down-stroke, see below.

Indicates: Low/no catalyst at top (T) and bottom (B) of the pump stroke.

Probable Cause: There is no or improper accumulation effect in the catalyst system. Normally this is only a problem at high pressures.

Solution: Check to be sure you are using the proper catalyst hose, with or without core. Install a catalyst accumulator if needed. Check for a restriction in the catalyst system. (For chargeable accumulator systems see section below)

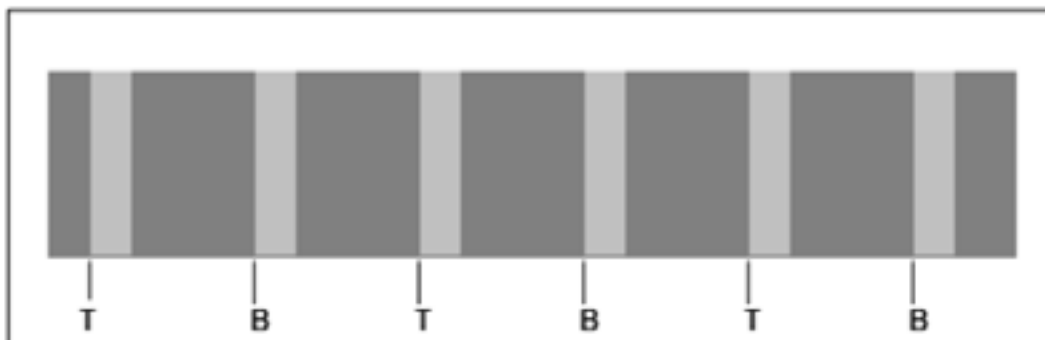

* Improper cure at the top and bottom of the stroke indicates an accumulation issue; either catalyst or resin.

Result 2:

Material delivered at the top and bottom of the stroke is hot (curing very rapidly). Also thin areas of material might be noticeable compared to the volume delivered in the middle of the stroke, see figure above.

Indicates: Low resin at the top (T) and bottom (B) of the pump stroke.

Probable Cause: There is no or improper accumulation effect in the resin system.

Solution: Resin accumulator full of hard material or has a blockage. Clean resin filter and reinstall. Incorrect accumulator installed. Pump pressure is too high, lower resin pressure. (For chargeable accumulator systems see section below)

Result 3:

Material delivered on the catalyst pump up-stroke (from the bottom of the stroke to the top) is not curing or slow cure (see figure below).

Indicates: No catalyst is being delivered on the up-stroke.

Probable Cause:

- Worn or damaged catalyst piston seal
- Damaged catalyst pump cylinder.
- Worn or damaged piston body ball.
- Damaged piston body ball seat.

Solution: Replace worn and damaged parts, see Service and Repair Manual.

Result 4:

Material delivered on the catalyst pump down-stroke (from the top of the stroke to the bottom) is not curing or slow cure (see figure below).

Indicates: No catalyst is being delivered on the down-stroke.

Probable Cause:

- Worn or damaged inlet body.
- Worn or damaged inlet body ball.

Solution: Replace worn and damaged parts, see Service and Repair Manual.

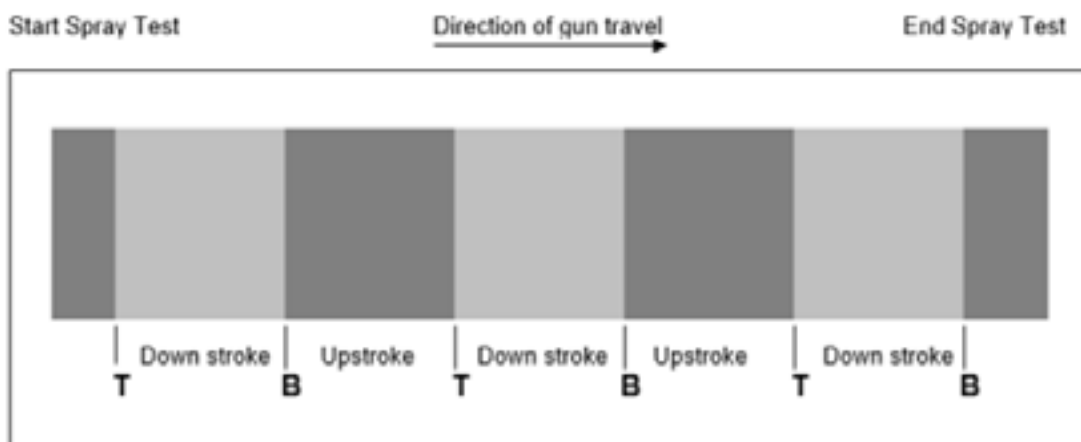

Result 5:

Material is delivered with streaks running the length of the test spray. Some strips cure normally, some not at all, other cure at faster or slower rates (see figure below). This is not a pumping problem, it is a mixing problem.

Indicates: A mixing problem and the fan is delivering streams of poorly catalyzed resin and/or pure catalyst.

Probable Cause: The Turbulent Mixer is worn, clogged or damaged in some way. A scratched or damaged Mix Chamber can also cause this problem.

Solution: Shut down the system and inspect the Turbulent Mixer and Mix Chamber. Repair or replace as needed.

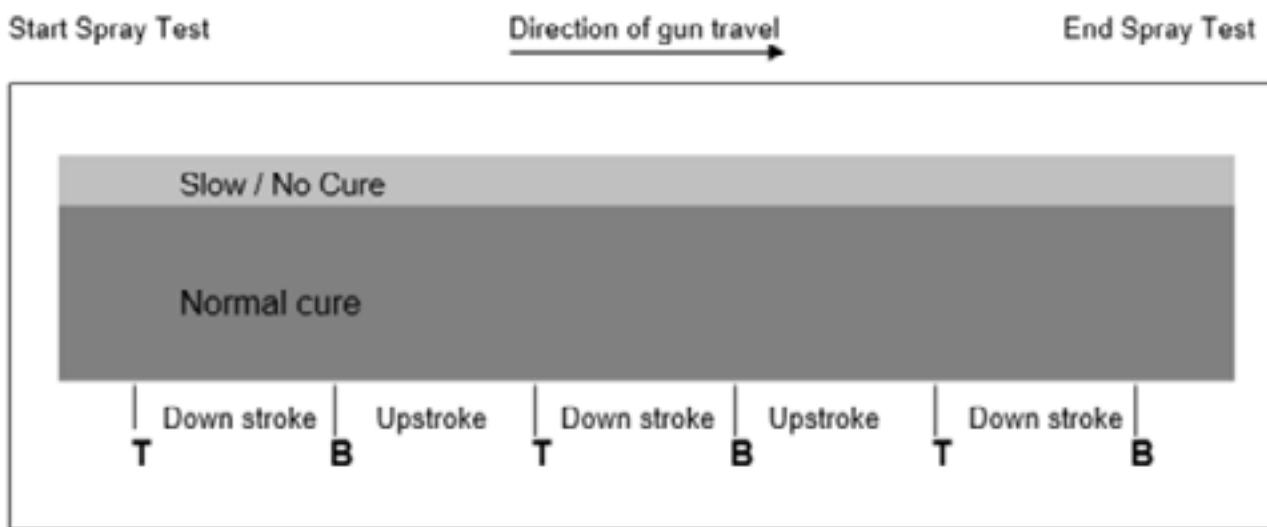

Test Results for Needle Style Guns

Result 6:

Material delivered at the beginning of the test strip is hot (low in resin), followed immediately by material that is cold (low in catalyst), followed by material that is properly mixed and cures. (see below)

Indicates: system is unbalanced at the beginning of the spray. Low resin is delivered upon pulling the trigger of the gun followed by low catalyst delivery. After a moment or two, the system balances and properly mixed material is delivered.

Probable Cause: The catalyst needle on the gun opens before the resin needle.

Solution: Adjust the catalyst and resin needles to the proper settings.

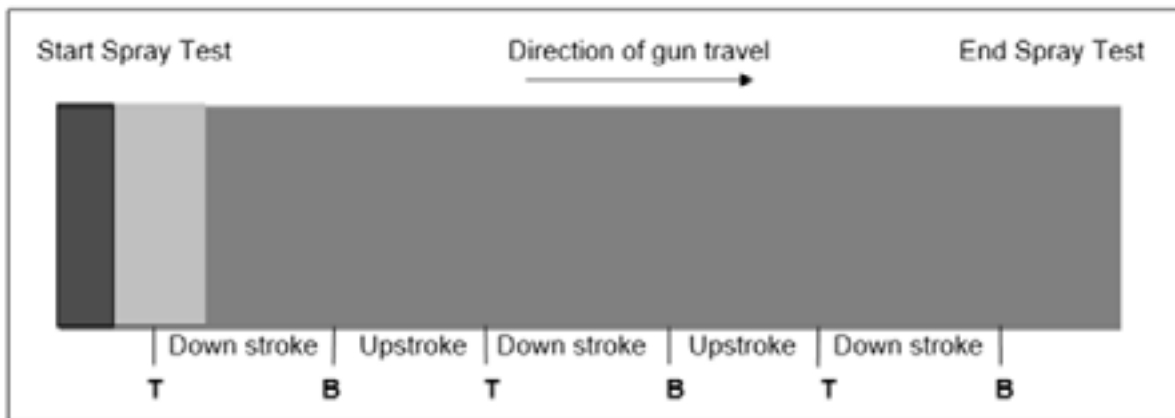

Result 7:

Material delivered at the beginning of the test spray is cold (low catalyst), followed by material that is properly mixed and cures. (See below)

Indicates: The system is unbalanced at the beginning of the spray. No catalyst at the beginning of the spray, followed by normal mix and spray.

Probable Cause: The resin needle is opening too soon before the catalyst needle. This means a shot of pure uncatalyzed resin will be delivered until the catalyst needle is opened.

Solution: Adjust the catalyst and resin needles to the proper settings.

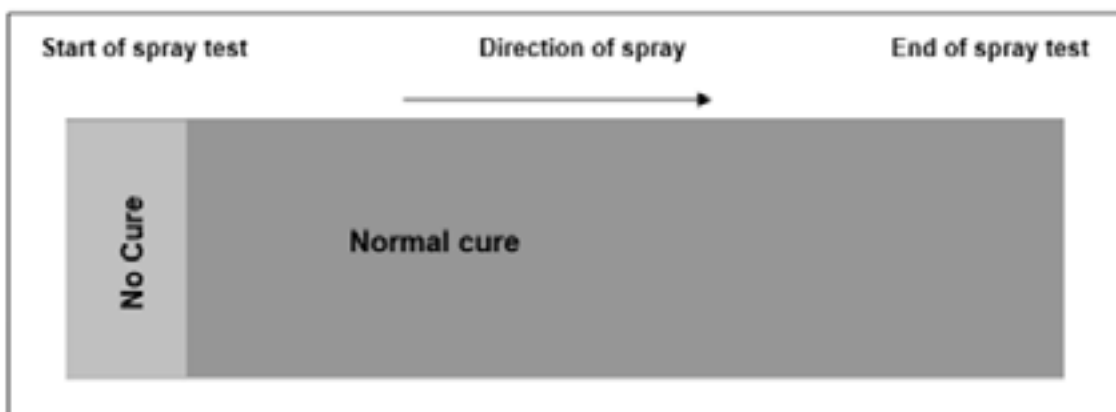

Start-Up & Shut-Down : Internal Mix

Pre-Start Checklist: Internal Mix

Activities must be done in the sequence shown, and must be ticked off as completed. use this checklist in conjunction with the operating manual for the ultramax unit.

Note: Wear a respirator as specified for spray painting, Protective Clothing, Eye Protection, and PVC Gloves before operating your Pro System.

Order	Activity	Completed
1	Tools and materials are available for pre-start checks.	
2	Incoming airline is ½ inch.	
3	Incoming airline is connected to the inlet manifold.	
4	Earth straps are connected to the resin drum and to earth.	
5	Incoming air valve is in the OPEN position.	
6	Air supply is ON.	
7	At the Manifold, open the air supply to the gun.	
8	Seat the catalyst and resin seals on the ProGun.	
9	Compress the resin pump packing.	
10	Check for oil in the pump reservoir.	
11	Adjust the Catalyst Pump Packing Nut.	
12	Check that there is Catalyst in the Catalyst Bottle.	
13	Check that the Catalyst Bottle Cap is in place.	
14	Place the Resin Pick-up wand in the resin supply container.	
15	Place the end of the Resin Return Hose in the resin container.	
16	Fill the Solvent Flush Tank.	
17	At the Manifold, turn the Air Pressure on to the Solvent Flush Tank - 60psi	
18	Flush the mix chamber on the ProGun	
19	Remove air from the Catalyst feed line to the Catalyst Pump.	
20	Close the ball valve below the Surge Chamber.	

Issue / Problem/ Observation	Correction	Completed

Operator Name: _____

Date: _____

First Time Checklist: Internal Mix

Activities must be done in the sequence shown, and must be ticked off as completed. This sequence follows the *Pre-Start Checklist*.

Note: Wear a respirator as specified for spray painting, Protective Clothing, Eye Protection, and PVC Gloves before operating your Pro System.

Order	Activity	Completed
1	Lock the Gun trigger in the Open position over an appropriate container.	
2	Remove the Pivot Pin from the Catalyst Pump.	
3	Manually pump the catalyst pump, observe for catalyst exiting the mix chamber on the gun. Leave the pivot pin out.	
4	Make sure the ball valve below the surge chamber is closed.	
5	Using the regulator on the manifold, slowly turn up the pump air pressure until the pump moves slowly and evenly.	
6	Turn up the air to the resin pump until air/resin exits the mix chamber on the gun.	
7	Turn the air to the pump down to zero.	
8	Disengage the gun trigger, leave it in the CLOSED position.	
9	Flush the mix chamber on the gun with acetone.	
10	Turn up the pump pressure to 40 psi.	
11	Hand prime the catalyst pump until the pressure rises on the catalyst pump pressure gauge.	
12	Replace the Pivot Pin in the catalyst slide drive, lock it in.	
13	Adjust catalyst percentage to the required setting.	
14	Insert the Distribution Ring into the Mix Chamber locating rim on the Pro Gun.	
15	Insert the Catalyst Injector into the aperture in the Distribution Ring.	
16	Place Resin Seal into the Mix Chamber locating rim.	
17	Place Mix Chamber and Catalyst Injector onto the front of the ProGun, secure it with two screws.	
18	Flush the assembled mix chamber with solvent.	

Issue / Problem/ Observation	Correction	Completed

Operator Name: _____

Date: _____

Daily Startup Checklist: Internal Mix

Activities must be done in the sequence shown, and must be ticked off as completed. This sequence follows the *First Time Checklist*.

Note: Wear a respirator as specified for spray painting, Protective Clothing, Eye Protection, and PVC Gloves before operating your Pro System.

Order	Activity	Completed
1	Check all hoses for damage.	
2	Check all material supplies and fill or replace as needed.	
3	Open main inlet air valve on the manifold.	
4	Open 3-way ball valve to the dump side.	
5	Remove the Pivot Pin from the catalyst pump.	
6	Manually pump the catalyst pump, observe catalyst returning to the catalyst jug, pump until the stream is air free.	
7	Close 3-way ball valve.	
8	Manually pump the catalyst pump, bring catalyst pressure to operating pressure 100 – 200 psi.	
9	Replace the Pivot Pin into the catalyst pump drive.	
10	Adjust the catalyst percentage as required.	
11	Check pump air regulator and gauge if needed use the regulator on the manifold, slowly turn up the pump air pressure to the operating pressure, 30 – 50 psi. If a safety override valve is installed press and hold the priming button while adjusting air pressure.	
12	Insert the Distribution Ring into the Mix Chamber locating rim.	
13	Place mix housing Seal into the Mix Chamber locating rim.	
14	Insert the Catalyst Injector and injector seal into the aperture in the Distribution Ring. The spring goes into the gun block.	
15	Place Mix Chamber and Catalyst Injector onto the front of the ProGun, secure it with 2 screws.	
16	Flush the Assembled mix chamber with solvent.	
17	Install mixer and nozzle onto the mix chamber.	

Issue / Problem/ Observation	Correction	Completed

Operator Name: _____

Date: _____

Shutdown Checklist: Internal Mix

Activities must be done in the sequence shown, and must be ticked off as completed. This sequence follows the *Daily Startup Checklist*.

Note: Wear a respirator as specified for spray painting, Protective Clothing, Eye Protection, and PVC Gloves before operating your Pro System.

Order	Activity	Completed
1	Flush the gun with solvent.	
2	Wipe the face of the nozzle after flushing.	
3	Turn off the air ball valve at the air intake.	
4	Release the solvent flush tank pressure	
5	Remove the nozzle and clean it.	
6	Remove the Mix Housing and clean it.	
7	Wipe the gun block face with a clean rag.	
8	Hang the gun with the gun block exit holes facing upwards.	

Issue / Problem/ Observation	Correction	Completed

Operator Name: _____

Date: _____

Start-Up & Shut-Down : External Mix

Pre-Start Checklist: External Mix

Activities must be done in the sequence shown, and must be ticked off as completed. use this checklist in conjunction with the operating manual for the ultramax unit.

Note: Wear a respirator as specified for spray painting, Protective Clothing, Eye Protection, and PVC Gloves before operating your Pro System.

Order	Activity	Completed
1	Tools and materials are available for pre-start checks.	
2	Incoming airline is ½ inch.	
3	Incoming airline is connected to the inlet manifold.	
4	Ground straps are connected to the resin drum and to earth.	
5	Incoming air valve is in the OPEN position.	
6	Air supply is ON.	
7	Remove nozzle cap, catalyst tip and nozzle.	
8	Check for oil in the pump reservoir, fill 1/3 full.	
9	Check that there is Catalyst in the Catalyst Bottle.	
10	Check that the Catalyst Bottle Cap and Screen are in place.	
11	Place the Resin Pick-up wand in the resin supply container.	
12	Place the end of the Resin Return Hose in the resin container.	
13	Remove air from the Catalyst feed line to the Catalyst Pump.	
14	Close the ball valve below the Surge Chamber.	

Issue / Problem/ Observation	Correction	Completed

Operator Name: _____

Date: _____

First Time Checklist: External Mix

Activities must be done in the sequence shown, and must be ticked off as completed. This sequence follows the *Pre-Start Checklist*.

Note: Wear a respirator as specified for spray painting, Protective Clothing, Eye Protection, and PVC Gloves before operating your Pro System.

Order	Activity	Completed
1	Remove the catalyst tip, spray tip and retaining ring off of the front of the gun.	
2	Remove the Pivot Pin from the Catalyst Pump.	
3	Manually pump the Catalyst Pump, observe for catalyst exiting the front of the gun. Leave the pivot pin out.	
4	Make sure the ball valve below the surge chamber is closed.	
5	Using the regulator on the manifold, slowly turn up the pump air pressure until the pump moves slowly and evenly.	
6	Turn up the air to the resin pump until air/resin exits the front of the gun.	
7	Turn the air to the pump down to zero.	
8	Disengage the gun trigger, leave it in the CLOSED position.	
9	Brush / clean the front of the gun with acetone.	
10	Turn up the pump pressure to 40 psi.	
11	Hand prime the Catalyst Pump until back pressure is felt.	
12	Adjust the catalyst percentage required.	
13	Replace the Pivot Pin in the catalyst slide drive, lock it in.	
14	Re-install the catalyst tip, spray tip and retaining ring on the front of the gun.	

Issue / Problem/ Observation	Correction	Completed

Operator Name: _____

Date: _____

Daily Startup Checklist: External Mix

Activities must be done in the sequence shown, and must be ticked off as completed. This sequence follows the *First Time Checklist*.

Note: Wear a respirator as specified for spray painting, Protective Clothing, Eye Protection, and PVC Gloves before operating your Pro System.

Order	Activity	Completed
1	Check all hoses for damage.	
2	Check all material supplies and fill or replace as needed.	
3	Open recirculation valve on Catalyst Pump.	
4	Open main inlet air valve on the manifold.	
5	Remove the Pivot Pin from the Catalyst Pump.	
6	Manually pump the Catalyst Pump, observe catalyst returning to the catalyst jug, pump until the stream is air free.	
7	Close recirculation valve on Catalyst Pump.	
8	Manually pump the Catalyst Pump until back pressure is felt.	
9	Check resin pump pressure, if needed slowly turn up the pump air pressure to the operating pressure, 30 – 50 psi. If a safety over ride valve is installed press and hold the priming button while adjusting air pressure	
10	Replace the Pivot Pin into the catalyst pump drive.	
11	Check atomizing air pressure, adjust as necessary.	
12	Lubricate the nozzle o-rings, stud o-rings and gun front threads	
13	Install nozzle and catalyst tip onto the gun.	

Issue / Problem/ Observation	Correction	Completed

Operator Name: _____

Date: _____

Shutdown Checklist: External Mix

Activities must be done in the sequence shown, and must be ticked off as completed. This sequence follows the *Daily Startup Checklist*.

Note: Wear a respirator as specified for spray painting, Protective Clothing, Eye Protection, and PVC Gloves before operating your Pro System.

Order	Activity	Completed
1	Wipe the face of the nozzle and catalyst tip with solvent.	
2	Turn off the main air ball valve at the air manifold.	
3	Remove the nozzle and catalyst tip and clean with solvent.	
4	Wipe the gun face clean with a rag or brush and solvent.	
5	Hang the gun with the gun block exit holes facing downwards.	

Issue / Problem/ Observation	Correction	Completed

Operator Name: _____

Date: _____

Gun Hose Connections:

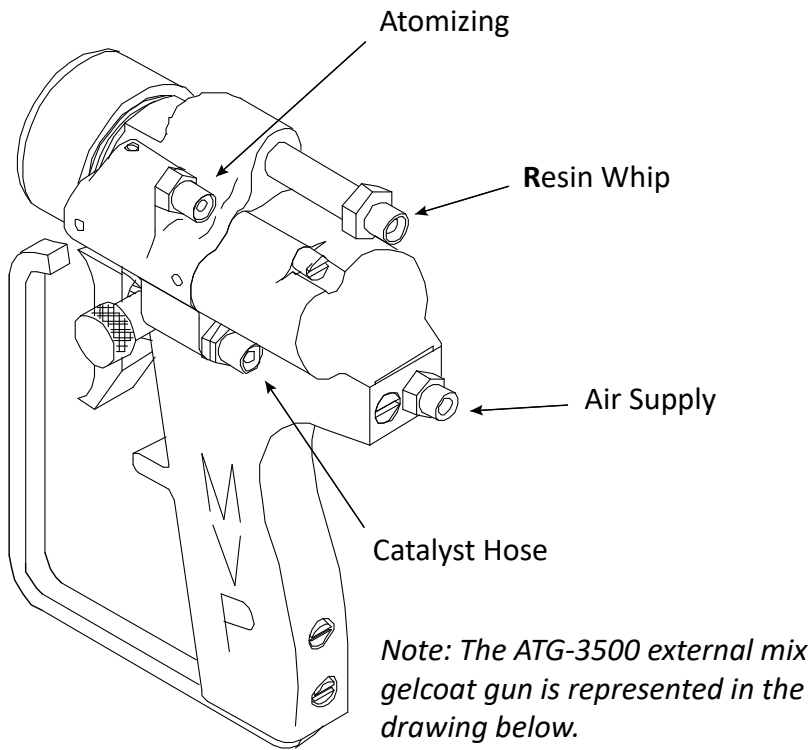

Maintenance

Lubrication

Throughout this manual, directions are given for lubricating various parts of the Patriot System. There are three types of lubricant used:

- If the part contacts resin, use MVP Red Grease (6706-2-1).
- If the part is located where it will contact air, use Lubriplate® (08465).
- Throat Seal Oil (PAT-LS-OIL) used in the oil reservoir of the pump.

Other Supplies

- Solvent for cleaning.
- A small Chip / Paint Brush for cleaning.
- Small cup or container for the solvent.
- Wet Gel Gauge to determine Gel Coat thickness.

Operation

Familiarize yourself with the Air Manifold controls, which consist of the following regulators and gages:

- PUMP PRESSURE gauge and regulator: This controls the main air pressure to the resin pump Air Motor.
- ATOMIZING-AIR gauge and regulator: This controls the air pressure to the catalyst nozzle on the gun. This is normally set to 18 – 25psi (1 -1.5 bar)
- RESIN DUMP VALVE (located on the Filter Body): This is used to relieve gel coat pressure.

Air Requirements

Clean, dry compressed air must be available at 90 – 100 psi (6 – 7 bar) and a minimum volume of 10 CFM (0.3 m3). Air must be provided through an air hose with a diameter of 0.5 inch (1.3 cm) or greater.

Troubleshooting

The most common problems with the equipment are diagnosed by analyzing the cured part.

Problem	Cause	Solution
Slow cure during upstroke	S.S. Ball in catalyst pump piston body not seating	Clean ball and inspect seat. Replace ball, piston seal or piston body if questionable.
Slow cure during down stroke	S.S. Ball in catalyst pump inlet body not seating	Clean ball and inspect seat. Replace ball or have seat repaired if questionable.
	Catalyst Check Valve (CV-2000) not working correctly	Inspect the Catalyst Check Valve (CV-2000). Repair or replace.
No cure or slow over-all cure	Catalyst pump set at too low or too high of a percentage	Move catalyst pump to a higher setting (closer to the gel coat pump). Verify the catalyst pump is in a vertical position.
	Catalyst supply below outlet fitting on jug	Fill catalyst jug 1/3 full.
	Quick pin not attached to pump or slave arm	Install quick pin. Install the catalyst pump in a vertical position.
	Catalyst leak	Check all fittings. The catalyst system must be fluid tight.
	Catalyst relief valve on catalyst pump is leaking	Relieve pressure from Pro pump. Clean and repair the Relief Valve.
	Catalyst suction screen in catalyst jug clogged	Clean suction screen and verify catalyst supply is not contaminated.
	Air lock in catalyst pump	Remove air lock.
	Catalyst pump piston seal worn or damaged	Replace piston seal; spring in seal faces top of pump.
	Catalyst pump outlet body damaged	Replace catalyst pump outlet body and piston seal. During reassembly, verify spring in seal faces top of pump and re-connect catalyst pump vertically.
	Catalyst pump check valve blocked or stuck	Disassemble check valve and remove blockage.
Catalyst hose plugged	Warning: System is pressurized Relieve pressure from the system and replace catalyst hose.	
	Gel coat too cold	Consult materials supplier for proper temperature. Maintain a draft-free environment of about 70 degrees F. An auxiliary heat source may be required to reduce gel time.
	Piston cups, piston ball, or pump cylinder worn.	Inspect the piston cups, piston ball, and pump cylinder. Clean and replace any damaged components.

The most common problems with the equipment are diagnosed by analyzing the cured part.

Problem	Cause	Solution
Low output on up-stroke of Pro pump	Clogged pump pick-up wand screen	Unscrew screen from hose and clean.
No fan, constant low output, or fast cure	Resin filter clogged	Disassemble and clean filter body and screen with solvent.
	Resin hose plugged	Warning: System is pressurized Relieve pressure from the system and flush hose with solvent. If material is hard, replace hose.
	Leaking pick-up wand assembly	Tighten assembly fittings.
	Resin filter clogged	Disassemble and clean the resin filter.
	Material cold or air pressure low.	Heat material or increase pump pressure.
Narrow Fan	Material cold, nozzle too large or air pressure low.	Heat Material, use smaller nozzle, or as a last resort increase pump pressure.
	Resin filter clogged	Disassemble and clean the resin filter.
Wide Fan	Air pressure too high	Lower pressure then increase pressure to the desired fan.
	Nozzle too small or too wide	Change nozzle.
Round fan	Orifice in nozzle worn, clogged, or damaged	Insert a thin wire through the rear face of the nozzle orifice. Use fingernail to clean material from "V" shaped notch in front. If notch is rough or worn, replace nozzle. Soak hardened material in solvent.
	Air-assist pressure too high	Decrease air-assist pressure.
Excessive Misting	Pump air pressure too high	Reduce air pressure to gel coat pump.
Heavy pulsation	Resin accumulator plugged	Warning: System is pressurized Relieve pressure from the system, then disassemble and clean the accumulator.
Pump jumps on upstroke	Piston ball worn or not seating properly	Replace piston ball and piston cups. Be sure to lubricate ball and cups thoroughly with PN# 6706-2-1.
Pump dives on down stroke	Foot valve, spring retainer, or foot valve ball is damaged or dirty	Clean or replace foot valve, spring retainer, and foot valve ball. Be sure to lubricate ball thoroughly with PN# 6706-2-1.
	Pick-up wand assembly not tight.	Tighten or seal joints of pick-up wand.
	Air in material.	Agitate material to remove air.

The most common problems with the equipment are diagnosed by analyzing the cured part.

Problem	Cause	Solution
Low output on up-stroke	Piston cups, piston ball, or pump cylinder worn	Inspect the piston cups, piston ball, and pump cylinder. Clean and replace any damaged components.
Pump does not run	Silencers on valve block plugged	Turn off air to pump and unscrew silencers. Clean silencers and re-install.
	Actuator valve or socket cap screw at shift block broken	Replace the broken cartridge valve or socket cap screw.
	Pro pump or hose plugged	Warning: System is pressurized Relieve fluid pressure from the system and disassemble and clean the Pro pump. Replace any worn parts. Replace hose(s) as needed.
	Air not connected	Check that air hose is connected to manifold, and regulator is at 20 psi or more.
	Air restricted	Straighten any kinks in air hoses.
Material in oil reservoir	Packing worn	Replace packing set in lower part of the pump.
	Piston rod worn or scored	Replace piston rod.
No Gel coat delivery on down stroke	Foot valve, spring retainer, or foot valve ball damaged or dirty	Clean or replace foot valve, spring retainer, and foot valve ball. Be sure to lubricate ball thoroughly with PN# 6706-2-1.
Hose leaks at fittings	Fitting loose	Tighten fitting. Check all fittings for leaks before operating.
	Fitting or nipple damaged.	Warning: System is pressurized Relieve fluid pressure from the system before attempting to inspect and replace damaged parts.
	Crimped hose.	Warning: System is pressurized Relieve fluid pressure from the system before attempting to inspect and replace damaged parts. If the hose has been sharply bent, the plastic liner may be ruptured and should be replaced.
Slow Cure on one side of the fan.	Turbulent Mixer clogged or damaged.	Clean or replace the Turbulent Mixer.
	Distribution Ring partly clogged.	Remove the mix chamber and clean the distribution ring.
	Mix Housing damaged	Inspect and replace as needed.

The most common problems with the equipment are diagnosed by analyzing the cured part.

Problem	Cause	Solution
Fingers – heavy lines in the spray fan.	Gel Coat too cold	Increase gel coat temperature. Use In-line resin heater.
	Pump air pressure too low	Slowly increase the pump pressure in 5psi (1/2 bar) increments and check spray fan.
	Air- Assist pressure is too low	Slowly Increase Air- Assist pressure as needed.
Pump has short travel – stuttering near top or bottom of stroke	Valve block is not shifting all the way or shifting before completing a full stroke.	Check air supply to shift block it should be 90 -100psi (6 – 7bar). Replace Actuator Valve (MPM-2589) or Valve (VPRO-2003) as needed.

Troubleshooting for AT Guns

Problem	Cause	Solution
Air leaking from exhaust port on back handle while trigger is OFF position.	O-ring material worn or cut.	Replace O-rings.
	O-rings on catalyst piston worn or cut.	
	O-rings on trigger valve worn or cut.	
Air leaking from exhaust port on back of handle while trigger in OFF or ON position.	O-rings on trigger valve worn or cut.	Replace O-rings.
	O-rings on catalyst valve and/or material piston worn or nicked.	
Catalyst leaking from catalyst tip while gun is sitting, not being triggered.	O-rings on catalyst valve worn or cut.	Replace O-rings.
Catalyst leaks from weep hole on catalyst side of gun.	O-rings on catalyst valve worn or cut.	Replace O-rings.
Catalyst leaks from weep hole on catalyst side of gun.	O-rings on catalyst valve worn or cut.	Replace O-rings.
No catalyst is coming from gun.	Catalyst air piston is not actuating.	Check for clogged catalyst air passages (small holes underneath back cylinder). Note: There is more than one passageway from holes.
	Plugged catalyst restrictor (Hex head screw with orifice located in front of catalyst valve).	Clean and clear orifice in front of catalyst valve.
	Plugged catalyst passageway in head of gun or catalyst tips.	Inspect, clean and clear passageways.
	No catalyst flow to gun.	See "Slave Pump-Trouble Shooting"
Material is leaking from tip (front of gun).	Loose diffuser seat.	Tighten diffuser seat 1/4 to 1/2 turn at a time until snug and then one more 1/4 turn. Over tightening of diffuser seat may cause binding of material needle.
	Worn needle and/or seat.	Replace worn items.
	O-ring on diffuser nicked or cut.	Replace O-rings.
Material is leaking from weep hole on material side of gun.	Loose diffuser seat.	Adjust until snug. Then turn 1/4 to 1/2 turn more. Don't over tighten.
	Worn needle packing	Replace packing and adjust as indicated above.

Catalyst Pump - Air Lock

An air lock is an air bubble in the catalyst pump that prevents catalyst flow. The piston body moves inside the bubble of air instead of pumping catalyst.

If you have determined that there is an air lock in your catalyst pump, follow the procedures in this section.

Warning: Fluids under High Pressure. Before performing any service and repair on this equipment, be sure to relieve air and fluid pressure.

1. Relieve line pressure from the catalyst pump by locking the gun open over an empty bucket. Leave the gun in this position.
2. Relieve pressure from the catalyst pump.
3. Remove the catalyst hose from the nipple on the catalyst pump. When removing hose, place a rag over the hose and fitting before loosening it.
4. Remove the quick pin from the catalyst bearing block and upper slave arm.
5. Tilt the pump toward the resin pump to release the air bubble.
 - 5a. If the bubble does not appear in the inlet tube, remove the lower quick pin and turn the pump upside-down.
6. Slowly hand-pump the catalyst into a suitable container until catalyst spurts from the nipple an equal amount on both the upstroke and down stroke.
7. Reconnect the catalyst hose to the nipple.
8. Hand-pump the catalyst pump until catalyst comes out through the gun.
9. Install the pump and quick pin into the slave arm.
10. Close the gun

Optional PRO-RECIRC Process

The air bubble can be quickly removed if the PRO-RECIRC option is installed on this equipment. Simply open the recirculation valve and hand prime catalyst back to the catalyst jug until there is a bubble free flow, then return the recirculation valve back to flow out the gun.

System Components

Note: Systems can be configured differently from the base lists below. Refer to the serial plates on system components to verify part numbers when ordering repair kits or replacement parts.

All MVP Service & Repair Manuals are available on our website.

<http://www.mvpind.com/application-support/technical-documents>

FIT-C-PAT-3 / FIT-C-PAT-7

FIT-C-PAT-7-INT / FIT-C-HVPAT-16

Core System Parts		
Part Number	Description	Application
01443-28	Acetone Hose	3:1 / 7:1 / INT /16:1
6101-01-01	Acetone Tank	3:1 / 7:1 / INT /16:1
6703-01-04	4' Drum Ground Wire	3:1 / 7:1 / INT /16:1
6703-02-020	Unit Ground Wire	3:1 / 7:1 / INT /16:1
6703-2-025	Gun Ground Wire	3:1 / 7:1 / INT
6706-1-1	Oil, Chopper Air Motor	3:1 / 7:1 / INT /16:1
6706-2-1	Grease, Resin Pump	3:1 / 7:1 / INT /16:1
HA-0644-25	Hose Assembly, 25'	3:1 / 7:1 / INT /16:1
HAW-046J6J-5	5' Airless Whip	16:1
HAW-121212-20	Hose Assembly, H.P.	16:1
HCHP-023J3J-25	HP Cat Hose Assembly	3:1 / 7:1 / INT /16:1
HFL-046J6J-5	Whip Hose	3:1 / 7:1 / INT
HFL-0888-20	FL. Hose Assembly	3:1 / 7:1 / INT
MS-2050-PAT	Patriot Cat Jug Assembly	3:1 / 7:1 / 16:1
PAT-MA-3	Air Manifold	3:1 / 7:1 / INT /16:1
PAT-CM-2A	Catalyst Manifold	3:1 / 7:1 / INT /16:1
PAT-FT-REG	Flush Tank Regulator	3:1 / 7:1 / INT /16:1
PAT-SV-HV	Safety Valve	16:1
PAT-SC-5000C-08	Surge Chamber / Filter	3:1 / 7:1 / INT /16:1
PAT-SV-1	Patriot Safety Valve	3:1 / 7:1 / INT
PAT-SWA-1000	Suction Wand Assembly	3:1 / 7:1 / INT

Catalyst Pump		
Part Number	Description	Application
PAT-CP-0980-S	Catalyst Pump	3:1 / 7:1 / INT
PAT-CP-0980-SK	Seal Kit	3:1 / 7:1 / INT
PAT-CP-1530	Catalyst Pump	16:1
PAT-CP-1530-SK	Seal Kit	16:1

Air Motors		
Part Number	Description	Application
PAT-PH-3250	Pump Assembly	3:1
PAT-PH-5000	Power Head 5"	7:1 / INT
PAT-PH-10000	Power Head Assembly 10"	16:1

Fluid Section		
Part Number	Description	Application
PAT-LS-24050	Fluid Section	3:1 / 7:1 / INT
PAT-LS-49090	Lower Section	16:1
PAT-LS-OIL	Patriot Lower Section Oil	3:1 / 7:1 / INT / 16:1

Slave Drives		
Part Number	Description	Application
PAT-SD-3100	Slave Drive Assembly	3:1 / 7:1 / INT
PAT-SD-4100	Slave Drive Assembly	16:1 /

Guns		
Part Number	Description	Application
CPC-2000-S	Pro Chopper Gun w/ Signal	3:1 / 7:1
CPC-2000-RK	Major Repair Kit	3:1 / 7:1
CP-TOOLS	Tool Kit, Classic Pro Gun	3:1 / 7:1
CPC-2000-S-INT	Pro Chop Gun w/ Signal	INT
CPC-2000-RK-INT	Major Repair Kit	INT
CP-TOOLS-INT	Tool Kit, Classic Pro Gun	INT
DMX-3000-ST-SIG	Duramax Gun	16:1
DMX-3000-ST-SK	Gun Seal Kit	16:1

Choppers		
Part Number	Description	Application
RC-1000-VFTC	Chopper for Venus Super	3:1 / 7:1
RC-1000-CPR	Chopper For CPR / Duramax	16:1
RC-1017	Blades, Box of 100	3:1 / 7:1 /16:1
RC-1021W	Anvil Sleeve, White	3:1 / 7:1 /16:1
VRC-3000-CPG	Classic Pro Chopper	INT
5103-6-1	Rubber Roll - 70	INT
5103-8-100	Chopper Blades	INT

FIT-W-PAT-3 / FIT-W-PAT-7 / FIT-W-HVPAT-16

Core System Parts		
Part Number	Description	Application
01443-28	Acetone Hose	3:1 / 7:1 / 16:1
6101-01-01	Acetone Tank	3:1 / 7:1 / 16:1
6703-01-04	4' Drum Ground Wire	3:1 / 7:1 / 16:1
6703-02-020	Unit Ground Wire	3:1 / 7:1 / 16:1
6703-2-025	Gun Ground Wire	16:1
6706-2-1	Grease, Resin Pump	3:1 / 7:1 / 16:1
HA-0344-25	Hose Assembly, 25'	3:1 / 7:1
HA-0644-25	Hose Assembly, 25'	16:1
HAW-046J6J-5	5' Airless Whip	16:1
HAW-121212-20	Hose Assembly, H.P.	16:1
HCHP-023J3J-25	HP Cat Hose Assembly	3:1 / 7:1 / 16:1
HFL-046J6J-5	Whip Hose	3:1 / 7:1
HFL-0888-20	FL. Hose Assembly	3:1 / 7:1
MS-2050-PAT	Patriot Cat Jug Assembly	3:1 / 7:1 / 16:1
PAT-MA-3	Air Manifold	3:1 / 7:1 / 16:1
PAT-CM-2A	Catalyst Manifold	3:1 / 7:1 / 16:1
PAT-FT-REG	Flush Tank Regulator	3:1 / 7:1 / 16:1
PAT-SC-5000C-08	Surge Chamber / Filter	3:1 / 7:1 / 16:1
PAT-SV-1	Patriot Safety Valve	3:1 / 7:1
PAT-SWA-1000	Suction Wand Assembly	3:1 / 7:1

Catalyst Pump		
Part Number	Description	Application
PAT-CP-0980-S	Catalyst Pump	3:1 / 7:1
PAT-CP-0980-SK	Seal Kit	3:1 / 7:1
PAT-CP-1530-S	Catalyst Pump	16:1
PAT-CP-1530-SK	Seal Kit	16:1

Air Motors		
Part Number	Description	Application
PAT-PH-3250	Pump Assembly	3:1
PAT-PH-5000	Power Head 5"	7:1
PAT-PH-10000	Power Head Assembly 10"	16:1

Fluid Section		
Part Number	Description	Application
PAT-LS-24050	Fluid Section	7:1
PAT-LS-49090	Lower Section	16:1
PAT-LS-OIL	Patriot Lower Section Oil	3:1 / 7:1 / 16:1

Slave Drives		
Part Number	Description	Application
PAT-SD-3100	Slave Drive Assembly	3:1 / 7:1
PAT-SD-4100	Slave Drive Assembly	16:1

Guns		
Part Number	Description	Application
CPW-2000-S	Pro Wetout Gun	3:1 / 7:1
CPC-2000-RK	Major Repair Kit	3:1 / 7:1
CP-TOOLS	Tool Kit, Classic Pro Gun	3:1 / 7:1
DMX-3000-W-ST5	Duramax Gun	16:1
DMX-3000-ST-SK	Gun Seal Kit	16:1

Choppers		
Part Number	Description	Application
RC-1000-VFTC	Chopper for Venus Super	3:1 / 7:1
RC-1000-CPR	Chopper For CPR / Duramax	16:1
RC-1017	Blades, Box of 100	3:1 / 7:1 / 16:1
RC-1021W	Anvil Sleeve, White	3:1 / 7:1 / 16:1
VRC-3000-CPG	Classic Pro Chopper	INT
5103-6-1	Rubber Roll - 70	INT
5103-8-100	Chopper Blades	INT

IMC-PAT-7 / IMC-PAT-15-746 / IMC-HVPAT-16

Core System Parts		
Part Number	Description	Application
01443-28	Acetone Hose	7:1 / 15:1 / 16:1
6101-01-01	Acetone Tank	7:1 / 15:1 / 16:1
6703-01-04	4' Drum Ground Wire	7:1 / 15:1 / 16:1
6703-02-020	Unit Ground Wire	7:1 / 15:1 / 16:1
6703-2-025	Gun Ground Wire	7:1 / 15:1 / 16:1
6706-1-1	Oil, Chopper Air Motor	7:1 / 15:1 / 16:1
6706-2-1	Grease, Resin Pump	7:1 / 15:1 / 16:1
HA-0644-25	Hose Assembly, 25'	7:1 / 15:1 / 16:1
HAW-046J6J-5	5' Airless Whip	15:1 / 16:1
HAW-0888-20	ASM	15:1
HAW-121212-20	Hose Assembly, H.P.	16:1
HCHP-023J3J-25	HP Cat Hose Assembly	7:1 / 15:1 / 16:1
HFL-0888-20	FL. Hose Assembly	7:1
MS-2050-PAT	Patriot Cat Jug Assembly	7:1 / 15:1 / 16:1
PAT-MA-3	Air Manifold	7:1 / 15:1 / 16:1
PAT-CM-2A	Catalyst Manifold	7:1 / 15:1
PAT-CM-3A	Catalyst Manifold	16:1
PAT-FT-REG	Flush Tank Regulator	7:1 / 15:1 / 16:1
PAT-SC-5000C-08	Surge Chamber / Filter	7:1 / 15:1 / 16:1
PAT-SV-1	Patriot Safety Valve	7:1 / 15:1
PAT-SV-HV	Safety Valve	16:1
PAT-SWA-1000	Suction Wand Assembly	7:1 / 15:1

Catalyst Pump		
Part Number	Description	Application
PAT-CP-0980-S	Catalyst Pump	7:1 / 15:1
PAT-CP-0980-SK	Seal Kit	7:1 / 15:1
PAT-CP-1530	Catalyst Pump	16:1
PAT-CP-1530-SK	Seal Kit	16:1

Air Motors		
Part Number	Description	Application
PAT-PH-5000	Power Head 5"	7:1
PAT-PH-7000-HD	Patriot Power Head 7"	15:1
PAT-PH-10000	Power Head Assembly 10"	16:1

Fluid Section		
Part Number	Description	Application
PAT-LS-24050	Fluid Section	7:1
PAT-LS-24050-HD	Fluid Section	15:1
PAT-LS-49090	Lower Section	16:1
PAT-LS-49090-SK	Seal Kit	16:1
PAT-LS-OIL	Patriot Lower Section Oil	7:1 / 15:1 / 16:1

Slave Drives		
Part Number	Description	Application
PAT-SD-3100	Base Slave Drive	7:1 / 15:1
PAT-SD-4100	Slave Drive Assembly	16:1

Guns		
Part Number	Description	Application
DMX-3000-SIG	Duramax Gun w/ Signal	7:1 / 15:1 / 16:1
DMX-3000-SK	Gun Seal Kit	7:1 / 15:1 / 16:1
FT-552	Flat Tip	7:1 / 15:1 / 16:1

Choppers		
Part Number	Description	Application
RC-1000-CPR	Chopper For CPR / Duramax	7:1 / 15:1 / 16:1
RC-1017	Blades, Box of 100	7:1 / 15:1 / 16:1
RC-1021W	Anvil Sleeve, White	7:1 / 15:1 / 16:1

IMC-PAT-7-INT / IMC-PAT-15-INT
IMC-PAT-30-INT / IMC-PAT-15746-INT

Core System Parts		
Part Number	Description	Application
01443-28	Acetone Hose	7:1/15:1/746/30:1
6101-01-01	Acetone Tank	7:1/15:1/746/30:1
6703-01-04	4' Drum Ground Wire	7:1/15:1/746/30:1
6703-02-020	Unit Ground Wire	7:1 / 15:1 / 30:1
6703-2-025	Gun Ground Wire	15:1 / 30:1
6706-1-1	Oil, Chopper Air Motor	7:1/15:1/746/30:1
6706-2-1	Grease, Resin Pump	7:1/15:1/746/30:1
HA-0644-25	Hose Assembly, 25'	7:1/15:1/746/30:1
HAW-0444-5	5' Airless Whip	7:1/15:1/746/30:1
HAW-0664-20	Hose Assembly, HP 3/8	7:1/15:1/746/30:1
HCHP-02313J-25	HP Cat Hose Assembly	7:1/15:1/746/30:1
PAT-CJ	Cat Jug Assembly	7:1 / 15:1 / 30:1
PAT-MA-3	Air Manifold	7:1/15:1/746/30:1
PAT-CM-2A	Catalyst Manifold	7:1 / 15:1 / 746
PAT-CM-2A-HP	Catalyst Manifold	30:1
PAT-FT-REG	Flush Tank Regulator	7:1/15:1/746/30:1
PAT-SC-5000C-06	Surge Chamber / Filter	7:1/15:1/746/30:1
PAT-SV-1	Patriot Safety Valve	7:1/15:1/746/30:1
PAT-SWA-1000	Suction Wand Assembly	7:1/15:1/746/30:1
UNIT-TOOLS-INT	Unit Tool Kit	7:1/15:1/746/30:1

Catalyst Pump		
Part Number	Description	Application
PAT-CP-0550	Catalyst Pump	15:1 / 30:1
PAT-CP-0550-SK	Seal Kit	15:1 / 30:1
PAT-CP-0980	Base Pump For Systems	7:1
PAT-CP-0980-SK	Seal Kit	7:1 / 746

Air Motors		
Part Number	Description	Application
PAT-PH-5000	Power Head 5"	7:1 / 15:1
PAT-PH-7000-HD	Patriot Power Head 7"	746 / 30:1

Fluid Section		
Part Number	Description	Application
PAT-LS-12270	Fluid Section	15:1
PAT-LS-12270-HD	Fluid Section	30:1
PAT-LS-24050	Fluid Section	7:1
PAT-LS-24050-HD	Fluid Section	746
PAT-LS-OIL	Patriot Lower Section Oil	7:1/15:1/746/30:1

Slave Drives		
Part Number	Description	Application
PAT-SD-3100	Base Slave Drive	7:1 / 15:1 / 746

Guns		
Part Number	Description	Application
CPC-1000-S-INT	Classic Pro w/ Signal	7:1/15:1/746/30:1
CP-TOOLS-INT	Classic Pro Gun Tool Kit	7:1/15:1/746/30:1
58666-1-INT	Major Repair Kit	7:1/15:1/746/30:1

Choppers		
Part Number	Description	Application
VRC-3000-CPG	Chopper for Classic Pro	7:1/15:1/746/30:1
5103-8-100	Blades, Box of 100	7:1/15:1/746/30:1
5103-6-1	Rubber Roll - 70	7:1/15:1/746/30:1

IMG-PAT-15 / IMG-PAT-30 / IMG-PAT-15-746

Core System Parts		
Part Number	Description	Application
01443-28	Acetone Hose	15:1 / 30:1 / 746
6101-01-01	Acetone Tank	15:1 / 30:1 / 746
6703-01-04	4' Drum Ground Wire	15:1 / 30:1 / 746
6703-02-020	Unit Ground Wire	15:1 / 30:1 / 746
6706-2-1	Grease, Resin Pump	15:1 / 30:1 / 746
HA-0344-25	Hose Assembly, 25'	15:1 / 30:1 / 746
HAW-0444-5	5' Airless Whip	15:1 / 30:1 / 746
HAW-0664-20	Hose Assembly, HP 3/8	15:1 / 30:1 / 746
HCHP-023J3J-25	HP Cat Hose Assembly	15:1 / 30:1 / 746
MS-2050-PAT	Cat Jug Assembly	15:1 / 30:1 / 746
PAT-MA-3	Air Manifold	15:1 / 30:1 / 746
PAT-CM-2A	Catalyst Manifold	15:1 / 746
PAT-CM-2A-HP	Catalyst Manifold	30:1
PAT-FT-REG	Flush Tank Regulator	15:1 / 30:1 / 746
PAT-SC-5000G-06	Surge Chamber / Filter	15:1 / 30:1 / 746
PAT-SV-1	Patriot Safety Valve	15:1 / 30:1 / 746
PAT-SWA-1000	Suction Wand Assembly	15:1 / 30:1 / 746

Catalyst Pump		
Part Number	Description	Application
PAT-CP-0550S	Base Pump for Systems	15:1 / 30:1
PAT-CP-0550-SK	Seal Kit	15:1 / 30:1
PAT-CP-0980-S	Catalyst Pump	746
PAT-CP-0980-SK	Seal Kit	746

Air Motors		
Part Number	Description	Application
PAT-PH-5000	Power Head 5"	15:1
PAT-PH-7000-HD	Patriot Power Head 7"	30:1

Fluid Section		
Part Number	Description	Application
PAT-LS-12270	Fluid Section	15:1
PAT-LS-12270-HD	Fluid Section	30:1
PAT-LS-24050	Fluid Section	
PAT-PA-15750-HD	Pump Assembly	746
PAT-LS-OIL	Patriot Lower Section Oil	15:1 / 30:1 / 746

Slave Drives		
Part Number	Description	Application
PAT-SD-3100	Slave Drive	746 / 15:1 / 30:1

Guns		
Part Number	Description	Application
CPG-1000-S-INT	Pro Gelcoat Gun w/ Signal	15:1 / 30:1 / 746
58666-1-INT	Major Repair Kit	15:1

IMG-PAT-15-INT / IMG-PAT-30-INT

Core System Parts		
Part Number	Description	Application
01443-28	Acetone Hose	15:1 / 30:1
6101-01-01	Acetone Tank	15:1 / 30:1
6703-01-04	4' Drum Ground Wire	15:1 / 30:1
6703-02-020	Unit Ground Wire	15:1 / 30:1
6706-2-1	Grease, Resin Pump	15:1 / 30:1
HA-0344-25	Hose Assembly, 25'	15:1 / 30:1
HAW-0444-5	5' Airless Whip	15:1 / 30:1
HAW-0664-20	Hose Assembly, HP 3/8	15:1 / 30:1
HCHP-023J3J-25	HP Cat Hose Assembly	15:1 / 30:1
PAT-CJ	Cat Jug Assembly	15:1
MS-2050-PAT	Patriot Cat Jug Assembly	30:1
PAT-MA-3	Air Manifold	15:1 / 30:1
PAT-CM-2A	Catalyst Manifold	15:1
PAT-CM-2A-HP	Catalyst Manifold	30:1
PAT-FT-REG	Flush Tank Regulator	15:1 / 30:1
PAT-SC-5000G-06	Surge Chamber / Filter	15:1 / 30:1
PAT-SV-1	Patriot Safety Valve	15:1 / 30:1
PAT-SWA-1000	Suction Wand Assembly	15:1 / 30:1
UNIT-TOOLS-INT	Unit Tool Kit	15:1

Catalyst Pump		
Part Number	Description	Application
PAT-CP-0550-S	Base Pump for Systems	15:1 / 30:1
PAT-CP-0550-SK	Seal Kit	15:1 / 30:1

Air Motors		
Part Number	Description	Application
PAT-PH-5000	Power Head 5"	15:1
PAT-PH-7000-HD	Patriot Power Head 7"	30:1

Fluid Section		
Part Number	Description	Application
PAT-LS-12270	Fluid Section	15:1
PAT-LS-12270-HD	Fluid Section	30:1
PAT-LS-OIL	Patriot Lower Section Oil	15:1 / 30:1

Slave Drives		
Part Number	Description	Application
PAT-SD-3100	Base Slave Drive	15:1 / 30:1

Guns		
Part Number	Description	Application
CPG-1000-S-INT	Pro Gelcoat Gun w/ Signal	15:1 / 30:1
CP-TOOLS-INT	Classic Pro Gun Tool Kit	15:1
58666-1-INT	Major Repair Kit	15:1 / 30:1

IMW-PAT-7 / IMW-PAT-15-746 / IMW-HVPAT-16

Core System Parts		
Part Number	Description	Application
01443-28	Acetone Hose	7:1 / 16:1 / 746
6101-01-01	Acetone Tank	7:1 / 16:1 / 746
6703-01-04	4' Drum Ground Wire	7:1 / 16:1 / 746
6703-02-020	Unit Ground Wire	7:1 / 16:1 / 746
6706-2-1	Grease, Resin Pump	7:1 / 16:1 / 746
HA-0344-25	Hose Assembly, 25'	7:1 / 16:1 / 746
HAW-046J6J-5	5' Airless Whip	16:1 / 746
HAW-0888-20	ASM	16:1 / 746
HCHP-023J3J-25	HP Cat Hose Assembly	7:1 / 16:1 / 746
HFL-046J6J-5	Whip Hose	7:1
HFL-0888-20	FL Hose Assembly	7:1
MS-2050-PAT	Patriot Cat Jug Assembly	7:1 / 16:1 / 746
PAT-MA-3	Air Manifold	7:1 / 16:1 / 746
PAT-CM-2A	Catalyst Manifold	7:1 / 16:1 / 746
PAT-FT-REG	Flush Tank Regulator	7:1 / 16:1 / 746
PAT-SC-5000C-06	Surge Chamber / Filter	746
PAT-SC-5000C-08	Surge Chamber / Filter	7:1 / 16:1
PAT-SV-1	Patriot Safety Valve	7:1 / 16:1 / 746
PAT-SWA-1000	Suction Wand Assembly	7:1 / 746

Catalyst Pump		
Part Number	Description	Application
PAT-CP-0980-S	Base Pump for Systems	7:1 / 746
PAT-CP-0980-SK	Seal Kit	7:1 / 746
PAT-CP-1530	Catalyst Pump	16:1
PAT-CP-1530-SK	Seal Kit	16:1

Air Motors		
Part Number	Description	Application
PAT-PH-5000	Power Head 5"	7:1
PAT-PH-7000-HD	Patriot Power Head 7"	746
PAT-PH-10000	Power Head 10"	16:1

Fluid Section		
Part Number	Description	Application
PAT-LS-24050-HD	Fluid Section	7:1 / 746
PAT-LS-49090	Lower Section	16:1
PAT-LS-OIL	Patriot Lower Section Oil	7:1 / 16:1 / 746

Slave Drives		
Part Number	Description	Application
PAT-SD-4100	Slave Drive	16:1
PAT-SD-3100	Base Slave Drive	746

Guns		
Part Number	Description	Application
DMX-3000-W-SIG	Duramax Wetout Gun	7:1 / 16:1 / 746
DMX-3000-SK	Duramax Seal Kit	7:1 / 16:1 / 746
FT-552	Flat Tip	7:1

**IMW-PAT-3-INT / IMW-PAT-7-INT / IMW-PAT-15-INT
IMW-PAT-30-INT / IMW-PAT-15746INT**

Core System Parts		
Part Number	Description	Application
01443-28	Acetone Hose	3:1/7:1/15:1/30:1/746
58666-1-INT	Major Repair Kit	3:1 / 7:1 / 746 / 30:1
6101-01-01	Acetone Tank	3:1/7:1/15:1/30:1/746
6703-01-04	4' Drum Ground Wire	3:1/7:1/15:1/30:1/746
6703-02-020	Unit Ground Wire	3:1/7:1/15:1/30:1/746
6706-2-1	Grease, Resin Pump	3:1/7:1/15:1/30:1/746
HA-0344-25	Hose Assembly, 25'	3:1/7:1/15:1/30:1/746
HAW-0444-5	5' Airless Hose	3:1/7:1/15:1/30:1/746
HAW-0664-20	Hose Assembly, 3/8 HP	3:1/7:1/15:1/30:1/746
HCHP-023J3J-25	HP Cat Hose Assembly	3:1/7:1/15:1/30:1/746
PAT-CJ	Cat Jug Assembly	15:1
PAT-MA-3	Air Manifold	3:1/7:1/15:1/30:1/746
PAT-CM-2A	Catalyst Manifold	3:1 / 7:1 / 15:1 / 746
PAT-CM-2A-HP	Catalyst Manifold	30:1
PAT-FT-REG	Flush Tank Regulator	3:1/7:1/15:1/30:1/746
PAT-SC-5000C-06B	Surge Chamber / Filter	15:1
PAT-SC-5000C-06	Surge Chamber / Filter	3:1 / 7:1 / 30:1 / 746
PAT-SV-1	Patriot Safety Valve	3:1 / 7:1 / 15:1 / 30:1
PAT-SWA-1000	Suction Wand Assembly	3:1/7:1/15:1/30:1/746
UNIT-TOOLS-INT	Unit Tool Kit	7:1 / 15:1 / 746 / 30:1

Air Motors		
Part Number	Description	Application
PAT-PH-3250	Power Head 3.25"	3:1
PAT-PH-5000	Power Head 5"	7:1 / 15:1
PAT-PH-7000-HD	Patriot Power Head 7"	30:1 / 746

Fluid Section		
Part Number	Description	Application
PAT-LS-12270	Fluid Section	15:1
PAT-LS-12270-HD	Fluid Section	30:1
PAT-LS-24050	Fluid Section	3:1 / 7:1
PAT-LS-24050-HD	Fluid Section	746
PAT-LS-OIL	Patriot Lower Section Oil	3:1/7:1/15:1/30:1/746

Slave Drives		
Part Number	Description	Application
PAT-SD-3100	Base Slave Drive	3:1/7:1/15:1/30:1/746

Guns		
Part Number	Description	Application
CPW-1000-S-INT	Pro Wetout Gun	3:1/7:1/15:1/30:1/746
CP-TOOLS-INT	Tool Kit, Classic Pro Gun	3:1/7:1/15:1/30:1/746

Catalyst Pump		
Part Number	Description	Application
PAT-CP-0550-S	Base Pump for Systems	15:1 / 30:1
PAT-CP-0550-SK	Seal Kit	15:1 / 30:1
PAT-CP-0980-S	Base Pump for Systems	3:1 / 7:1 / 746
PAT-CP-0980-SK	Seal Kit	3:1 / 7:1 / 746

MCS-PAT-7 / MCS-PAT-15-746

Core System Parts		
Part Number	Description	Application
01443-28	Acetone Hose	7:1 / 746
6101-01-01	Acetone Tank	7:1 / 746
6703-01-04	4' Drum Ground Wire	7:1 / 746
6703-02-020	Unit Ground Wire	7:1 / 746
6703-2-025	Gun Ground Wire	7:1
6706-1-1	Oil, Chopper Air Motor	7:1 / 746
6706-2-1	Grease, Resin Pump	7:1 / 746
HA-0224-25	Hose Assembly, 25'	7:1 / 746
HA-0324-25	Hose Assembly, 25'	7:1 / 746
HA-0644-25	Hose Assembly, 25'	7:1 / 746
HAW-0444-5	5' Airless Whip	746
HAW-0664-20	Hose Assembly, HP 3/8	746
HC-0224-25	Hose Assembly	7:1 / 746
HFL-0666-25	FL. Hose Assembly	7:1
MS-2050-PAT	Patriot Cat Jug Assembly	7:1 / 746
PAT-MA-9	Air Manifold	7:1 / 746
PAT-CM-3A	Catalyst Manifold	7:1 / 746
PAT-SC-5000C-06	Surge Chamber / Filter	7:1 / 746
PAT-SV-1	Patriot Safety Valve	7:1 / 746
PAT-SWA-1000	Suction Wand Assembly	7:1 / 746

Catalyst Pump		
Part Number	Description	Application
PAT-CP-0980-S	Base Pump For Systems	7:1 / 746
PAT-CP-0980-SK	Seal Kit	7:1 / 746

Air Motors		
Part Number	Description	Application
PAT-PH-5000	Power Head 5"	7:1
PAT-PH-7000-HD	Patriot Power Head 7"	746

Fluid Section		
Part Number	Description	Application
PAT-LS-24050	Fluid Section	7:1
PAT-LS-24050-HD	Fluid Section	746
PAT-LS-OIL	Patriot Lower Section Oil	746

Slave Drives		
Part Number	Description	Application
PAT-SD-3100	Base Slave Drive	7:1 / 746

Guns		
Part Number	Description	Application
ATC-6000	Chop Gun //With	7:1 / 746
AT-EXT-SK	Seal Kit	7:1 / 746
ATC-40323-BT	Gun Tools	7:1 / 746

Choppers		
Part Number	Description	Application
RC-1000-ATC	Chopper For ATC	7:1 / 746
RC-1017	Blades, Box of 100	7:1 / 746
RC-1021W	Anvil Sleeve, White	7:1 / 746

MCS-PAT-7-INT / MCS-PAT-15746INT

Core System Parts		
Part Number	Description	Application
01443-28	Acetone Hose	7:1 / 746
6101-01-01	Acetone Tank	7:1 / 746
6703-01-04	4' Drum Ground Wire	7:1 / 746
6703-02-020	Unit Ground Wire	7:1 / 746
6703-2-025	Gun Ground Wire	7:1
6706-1-1	Oil, Chopper Air Motor	7:1
6706-2-1	Grease, Resin Pump	7:1 / 746
HA-0224-25	Hose Assembly, 25'	7:1 / 746
HA-0324-25	Hose Assembly, 25'	7:1 / 746
HA-0644-25	Hose Assembly, 25'	7:1 / 746
HAW-0444-5	5' Airless Whip	746
HAW-0664-20	Hose Assembly, HP 3/8	746
HCHP-023J3J-25LC	HP Cat Hose Assembly	7:1 / 746
HFL-0666-25	FL. Hose Assembly	7:1
MS-2050-PAT	Patriot Cat Jug Assembly	7:1 / 746
PAT-GFC-0980	Gravity Feed Kit	7:1 / 746
PAT-MA-9	Air Manifold	7:1 / 746
PAT-CM-3A	Catalyst Manifold	7:1 / 746
PAT-SC-5000C-06	Surge Chamber / Filter	7:1 / 746
PAT-SV-1	Patriot Safety Valve	7:1 / 746
PAT-SWA-1000	Suction Wand Assembly	7:1 / 746
UNIT-TOOLS-INT	Unit Tool Kit	746

Catalyst Pump		
Part Number	Description	Application
PAT-CP-0980-S	Base Pump For Systems	7:1 / 746
PAT-CP-0980-SK	Seal Kit	7:1 / 746

Air Motors		
Part Number	Description	Application
PAT-PH-5000	Power Head 5"	7:1
PAT-PH-7000-HD	Patriot Power Head 7"	746

Fluid Section		
Part Number	Description	Application
PAT-LS-24050	Fluid Section	7:1
PAT-LS-24050-HD	Fluid Section	746
PAT-LS-OIL	Patriot Lower Section Oil	746

Slave Drives		
Part Number	Description	Application
PAT-SD-3100	Slave Drive	7:1 / 746

Guns		
Part Number	Description	Application
ATC-6000-INT	Chop Gun /With	7:1 / 746
AT-EXT-SK	Seal Kit	7:1 / 746
ATC-40103-1	Tool O-Ring	7:1 / 746
ATC-40204-1	Tool O-Ring	7:1 / 746
ATC-40323-A-TL	5/16 Nut Driver	7:1 / 746
ATC-40323-BT	Gun Tools	7:1 / 746

Choppers		
Part Number	Description	Application
RC-1000-ATC	Chopper For ATC	7:1 / 746
RC-1017	Blades, Box of 100	7:1 / 746
RC-1021W	Anvil Sleeve, White	7:1 / 746

MGS-PAT-15 / MGS-PAT-15-746

Core System Parts		
Part Number	Description	Application
01443-28	Acetone Hose	15:1 / 30:1 / 746
6101-01-01	Acetone Tank	15:1 / 30:1 / 746
6703-01-04	4' Drum Ground Wire	15:1 / 30:1 / 746
6703-02-020	Unit Ground Wire	15:1 / 30:1 / 746
6706-2-1	Grease, Resin Pump	15:1 / 30:1 / 746
HA-0224-25	Hose Assembly, 25'	15:1 / 30:1 / 746
HA-0344-25	Hose Assembly, 25'	15:1 / 30:1 / 746
HAW-0444-5	5' Airless Whip	15:1 / 30:1 / 746
HAW-0664-20	Hose Assembly, HP 3/8	15:1 / 30:1 / 746
HC-0224-25	Hose Assembly	15:1 / 30:1 / 746
MS-2050-PAT	Patriot Cat Jug Assembly	15:1 / 30:1 / 746
PAT-MA-4	Air Manifold	15:1 / 30:1 / 746
PAT-CM-3A	Catalyst Manifold	15:1 / 30:1 / 746
PAT-SC-5000G-06	Surge Chamber / Filter	15:1 / 30:1 / 746
PAT-SV-1	Patriot Safety Valve	15:1 / 30:1 / 746
PAT-SWA-1000	Suction Wand Assembly	15:1 / 30:1 / 746

Catalyst Pump		
Part Number	Description	Application
PAT-CP-0550-S	Base Pump For Systems	15:1 / 30:1
PAT-CP-0550-SK	Seal Kit	15:1 / 30:1
PAT-CP-0980-S	Base Pump For Systems	746
PAT-CP-0980-SK	Seal Kit	746

Air Motors		
Part Number	Description	Application
PAT-PH-5000	Power Head 5"	15:1
PAT-PH-7000-HD	Patriot Power Head 7"	30:1 / 746

Fluid Section		
Part Number	Description	Application
PAT-LS-12270	Fluid Section	15:1
PAT-LS-12270-HD	Fluid Section	30:1
PAT-LS-24050-HD	Fluid Section	746
PAT-LS-OIL	Patriot Lower Section Oil	15:1 / 30:1 / 746

Slave Drives		
Part Number	Description	Application
PAT-SD-3100	Slave Drive	15:1 / 30:1 / 746

Guns		
Part Number	Description	Application
ATG-6500	Gel Gun /With	15:1 / 30:1 / 746
AT-EXT-SK	Seal Kit	15:1 / 30:1 / 746
ATC-40323-BT	Gun Tool	15:1 / 30:1 / 746

MGS-PAT-15-INT / MGS-PAT-30-INT

Core System Parts		
Part Number	Description	Application
01443-28	Acetone Hose	15:1 / 30:1
6101-01-01	Acetone Tank	15:1 / 30:1
6703-01-04	4' Drum Ground Wire	15:1 / 30:1
6703-02-020	Unit Ground Wire	15:1 / 30:1
6706-2-1	Grease, Resin Pump	15:1 / 30:1
HA-0224-25	Hose Assembly, 25'	15:1 / 30:1
HA-0344-25	Hose Assembly, 25'	15:1 / 30:1
HAW-0444-5	5' Airless Whip	15:1 / 30:1
HAW-0664-20	Hose Assembly, HP 3/8	15:1 / 30:1
HCHP-023J3J-25LC	HP Cat Hose Assy.	15:1 / 30:1
PAT-CJ	Catalyst Jug Assembly	15:1 / 30:1
PAT-MA-4	Air Manifold	15:1 / 30:1
PAT-CM-3A	Catalyst Manifold	15:1
PAT-CM-3A-INT	Catalyst Manifold, INT	30:1
PAT-SC-5000G-06	Surge Chamber / Filter	15:1 / 30:1
PAT-SV-1	Patriot Safety Valve	15:1 / 30:1
PAT-SWA-1000	Suction Wand Assembly	15:1 / 30:1
UNIT-TOOLS-INT	Unit Tool Kit	30:1

Catalyst Pump		
Part Number	Description	Application
PAT-CP-0550-S	Base Pump For Systems	15:1 / 30:1
PAT-CP-0550-SK	Seal Kit	15:1 / 30:1

Air Motors		
Part Number	Description	Application
PAT-PH-5000	Power Head 5"	15:1
PAT-PH-7000-HD	Patriot Power Head 7"	30:1

Fluid Section		
Part Number	Description	Application
PAT-LS-12270	Fluid Section	15:1
PAT-LS-12270-HD	Fluid Section	30:1
PAT-LS-OIL	Patriot Lower Section Oil	15:1 / 30:1

Slave Drives		
Part Number	Description	Application
PAT-SD-3100	Slave Drive	15:1 / 30:1

Guns		
Part Number	Description	Application
ATG-6500-INT	Gel Gun /With	15:1 / 30:1
AT-EXT-SK	Seal Kit	15:1 / 30:1
ATC-40103-1	Tool O-Ring	15:1 / 30:1
ATC-40204-1	Tool O-Ring	15:1 / 30:1
ATC-40323-A-TL	5/16 Nut Driver	15:1 / 30:1
ATC-40323-BT	Gun Tools	15:1 / 30:1

MGS-PAT-2-15-746 / MGS-PAT-2-30

Core System Parts		
Part Number	Description	Application
01443-28	Acetone Hose	746 / 30:1
6101-01-01	Acetone Tank	746 / 30:1
6703-01-04	4' Drum Ground Wire	746 / 30:1
6703-02-020	Unit Ground Wire	746 / 30:1
6706-2-1	Grease, Resin Pump	746 / 30:1
BV-37A	Ball Valve	746 / 30:1
CV-1097-01	Check Valve	746
HA-0224-25	Hose Assembly, 25'	746 / 30:1
HA-0344-25	Hose Assembly, 25'	746 / 30:1
HAW-0444-5	5' Airless Whip	746 / 30:1
HAW-0664-20	Hose Assembly, HP 3/8	746 / 30:1
HC-0224-25	Hose Assembly	746 / 30:1
HCHP-023J3J-3LC	Cat Hose Less Core	746
MS-2050-PAT-2	Catalyst Jug Assembly	746 / 30:1
PAT-MA-4	Air Manifold	746 / 30:1
PAT-CM-3A	Catalyst Manifold	746 / 30:1
PAT-SC-5000G-06	Surge Chamber / Filter	746 / 30:1
PAT-SV-1	Patriot Safety Valve	746
PAT-SWA-1000	Suction Wand Assembly	746 / 30:1

Catalyst Pump		
Part Number	Description	Application
PAT-CP-0550-S	Base Pump For Systems	30:1
PAT-CP-0550-SK	Seal Kit	30:1
PAT-CP-0980-S	Base Pump For Systems	746
PAT-CP-0980-SK	Seal Kit	746

Air Motors		
Part Number	Description	Application
PAT-PH-7000-HD	Patriot Power Head 7"	746 / 30:1

Fluid Section		
Part Number	Description	Application
PAT-LS-12270-HD	Fluid Section	30:1
PAT-LS-24050-HD	Fluid Section	746
PAT-LS-OIL	Patriot Lower Section Oil	30:1

Slave Drives		
Part Number	Description	Application
PAT-SD-3100	Slave Drive	746 / 30:1

Guns		
Part Number	Description	Application
ATG-6500	Gel Gun /With	746 / 30:1
AT-EXT-SK	Seal Kit	746 / 30:1
ATC-40323-BT	Gun Tools	746 / 30:1

MWS-PAT-7 / MWS-PAT-15-746

Core System Parts		
Part Number	Description	Application
01443-28	Acetone Hose	7:1 / 746
6101-01-01	Acetone Tank	7:1 / 746
6703-01-04	4' Drum Ground Wire	7:1 / 746
6703-02-020	Unit Ground Wire	7:1 / 746
6706-2-1	Grease, Resin Pump	7:1 / 746
HA-0224-25	Hose Assembly, 25'	7:1 / 746
HA-0344-25	Hose Assembly, 25'	7:1 / 746
HAW-0444-5	5' Airless Whip	746
HAW-0664-20	Hose Assembly, HP 3/8	746
HC-0224-25	Hose Assembly	7:1 / 746
HFL-0666-25	Fluid Hose Assembly	7:1
MS-2050-PAT	Catalyst Jug Assembly	7:1 / 746
PAT-MA-4	Air Manifold	7:1 / 746
PAT-CM-3A	Catalyst Manifold	7:1 / 746
PAT-SC-5000C-06	Surge Chamber / Filter	7:1 / 746
PAT-SV-1	Patriot Safety Valve	7:1 / 746
PAT-SWA-1000	Suction Wand Assembly	7:1 / 746

Catalyst Pump		
Part Number	Description	Application
PAT-CP-0980-S	Base Pump For Systems	7:1 / 746
PAT-CP-0980-SK	Seal Kit	7:1 / 746

Air Motors		
Part Number	Description	Application
PAT-PH-5000	Power Head 5"	7:1
PAT-PH-7000-HD	Patriot Power Head 7"	746

Fluid Section		
Part Number	Description	Application
PAT-LS-24050	Fluid Section	7:1
PAT-LS-24050-HD	Fluid Section	746
PAT-LS-OIL	Patriot Lower Section Oil	7:1 / 746

Slave Drives		
Part Number	Description	Application
PAT-SD-3100	Slave Drive	7:1 / 746

Guns		
Part Number	Description	Application
ATG-6500-W	Wetout Gun /w Air Sig	7:1 / 746
AT-EXT-SK	Seal Kit	7:1 / 746
ATC-40323-BT	Gun Tools	7:1 / 746

MWS-PAT-7-INT / MWS-PAT-15746INT

Core System Parts		
Part Number	Description	Application
01443-28	Acetone Hose	7:1 / 746
6101-01-01	Acetone Tank	7:1 / 746
6703-01-04	4' Drum Ground Wire	7:1 / 746
6703-02-020	Unit Ground Wire	7:1 / 746
6706-2-1	Grease, Resin Pump	7:1 / 746
HA-0224-25	Hose Assembly, 25'	7:1 / 746
HA-0344-25	Hose Assembly, 25'	7:1 / 746
HAW-0444-5	5' Airless Whip	746
HAW-0664-20	Hose Assembly, HP 3/8	746
HCHP-023J3J-25LC	HP Cat Hose Assembly	7:1 / 746
HFL-0666-25	Fluid Hose Assembly	7:1
MS-2050-PAT	Catalyst Jug Assembly	7:1 / 746
PAT-MA-4	Air Manifold	7:1 / 746
PAT-CM-3A	Catalyst Manifold	7:1 / 746
PAT-SC-5000C-06	Surge Chamber / Filter	7:1 / 746
PAT-SV-1	Patriot Safety Valve	7:1 / 746
PAT-SWA-1000	Suction Wand Assembly	7:1 / 746

Catalyst Pump		
Part Number	Description	Application
PAT-CP-0980-S	Base Pump For Systems	7:1 / 746
PAT-CP-0980-SK	Seal Kit	7:1 / 746

Air Motors		
Part Number	Description	Application
PAT-PH-5000	Power Head 5"	7:1
PAT-PH-7000-HD	Patriot Power Head 7"	746

Fluid Section		
Part Number	Description	Application
PAT-LS-24050	Fluid Section	7:1
PAT-LS-24050-HD	Fluid Section	746
PAT-LS-OIL	Patriot Lower Section Oil	746

Slave Drives		
Part Number	Description	Application
PAT-SD-3100	Slave Drive	7:1

Guns		
Part Number	Description	Application
ATG-6500-W-INT	Wetout Gun International	7:1 / 746
AT-EXT-SK	Seal Kit	7:1 / 746
ATC-40103-1	Tool O-Ring	7:1 / 746
ATC-40204-1	Tool O-Ring	7:1 / 746
ATC-40323-A-TL	5/16 Nut Driver	7:1 / 746
ATC-40323-BT	Gun Tools	7:1 / 746

SF-FIT-C-PAT-3 / SF-FIT-C-PAT-7

Core System Parts		
Part Number	Description	Application
01443-28	Acetone Hose	3:1 / 7:1
6101-01-01	Acetone Tank	3:1 / 7:1
6703-01-04	4' Drum Ground Wire	3:1 / 7:1
6703-02-020	Unit Ground Wire	3:1 / 7:1
6703-2-025	Gun Ground Wire	3:1 / 7:1
6706-1-1	Oil, Chopper Air Motor	3:1 / 7:1
6706-2-1	Grease, Resin Pump	3:1 / 7:1
HA-0224-25	Hose Assembly, 25'	3:1 / 7:1
HA-0324-25	Hose Assembly, 25'	3:1 / 7:1
HA-0644-25	Hose Assembly, 25'	3:1 / 7:1
HC-0224-25	Hose Assembly	3:1 / 7:1
HFL-046J6J-5	Whip Hose	3:1 / 7:1
HFL-0888-20	Fluid Hose Assmby	3:1 / 7:1
MS-2050-PAT	Catalyst Jug Assembly	3:1 / 7:1
PAT-MA-9	Air Manifold	3:1 / 7:1
PAT-CM-3A	Catalyst Manifold	3:1 / 7:1
PAT-SC-5000C-08	Surge Chamber / Filter	3:1 / 7:1
PAT-SV-1	Patriot Safety Valve	3:1 / 7:1
PAT-SWA-1000	Suction Wand Assembly	3:1 / 7:1

Catalyst Pump		
Part Number	Description	Application
PAT-CP-0980-S	Base Pump For Systems	3:1 / 7:1
PAT-CP-0980-SK	Seal Kit	3:1 / 7:1

Air Motors		
Part Number	Description	Application
PAT-PH-3250	Power Head 3.25"	3:1
PAT-PH-5000	Patriot Power Head 5"	7:1

Fluid Section		
Part Number	Description	Application
PAT-LS-24050	Fluid Section	3:1 / 7:1
PAT-LS-OIL	Patriot Lower Section Oil	3:1 / 7:1

Slave Drives		
Part Number	Description	Application
PAT-SD-3100	Base Slave Drive	3:1 / 7:1

Guns		
Part Number	Description	Application
ATC-6000-FIT	Chop Fit Gun w/ Signal	3:1 / 7:1
AT-EXT-SK	Seal Kit	3:1 / 7:1
ATC-40323-BT	Gun Tools	3:1 / 7:1

Choppers		
Part Number	Description	Application
RC-1000-ATC-F	Chopper For ATC FIT	3:1 / 7:1
RC-1017	Blades, Box of 100	3:1 / 7:1
RC-1021W	Anvil Sleeve, White	3:1 / 7:1

SF-FIT-G-PAT-15 / SF-FIT-G-PAT-30 / SF-FIT-GPAT15746

Core System Parts		
Part Number	Description	Application
01443-28	Acetone Hose	15:1 / 30:1 / 746
6101-01-01	Acetone Tank	15:1 / 30:1 / 746
6703-01-04	4' Drum Ground Wire	15:1 / 30:1 / 746
6703-02-020	Unit Ground Wire	15:1 / 30:1 / 746
6706-2-1	Grease, Resin Pump	15:1 / 30:1 / 746
HA-0224-25	Hose Assembly, 25'	15:1 / 30:1 / 746
HA-0344-25	Hose Assembly, 25'	15:1 / 30:1 / 746
HAW-0444-5	5' Airless Hose	15:1 / 30:1 / 746
HAW-0664-20	Hose Assembly, HP 3/8	15:1 / 30:1 / 746
HC-0224-25	Hose Assembly	15:1 / 30:1 / 746
MS-2050-PAT	Catalyst Jug Assembly	15:1 / 30:1 / 746
PAT-MA-4	Air Manifold	15:1 / 30:1 / 746
PAT-CM-3A	Catalyst Manifold	15:1 / 30:1 / 746
PAT-SC-5000G-06	Surge Chamber / Filter	15:1 / 30:1 / 746
PAT-SV-1	Patriot Safety Valve	15:1 / 30:1 / 746
PAT-SWA-1000	Suction Wand Assembly	15:1 / 30:1 / 746

Catalyst Pump		
Part Number	Description	Application
PAT-CP-0550-S	Base Pump For Systems	15:1 / 30:1
PAT-CP-0550-SK	Seal Kit	15:1 / 30:1
PAT-CP-0980-S	Base Pump For Systems	746
PAT-CP-0980-SK	Seal Kit	746

Air Motors		
Part Number	Description	Application
PAT-PH-5000	Patriot Power Head 5"	15:1
PAT-PH-7000-HD	Patriot Power Head 7"	30:1 / 746

Fluid Section		
Part Number	Description	Application
PAT-LS-12270	Fluid Section	15:1
PAT-LS-12270-HD	Fluid Section	30:1
PAT-LS-24050-HD	Fluid Section	746
PAT-LS-OIL	Patriot Lower Section Oil	15:1 / 30:1 / 746

Slave Drives		
Part Number	Description	Application
PAT-SD-3100	Base Slave Drive	15:1 / 30:1 / 746

Guns		
Part Number	Description	Application
ATG-6500-FIT	Gel Gun w/ Signal	15:1 / 30:1 / 746
AT-EXT-SK	Seal Kit	15:1 / 30:1 / 746
ATC-40323-BT	Gun Tools	15:1 / 30:1 / 746

SF-FIT-W-PAT-3 / SF-FIT-W-PAT-7 / SF-FIT-WPAT15746

Core System Parts		
Part Number	Description	Application
01443-28	Acetone Hose	3:1 / 7:1 / 746
6101-01-01	Acetone Tank	3:1 / 7:1 / 746
6703-01-04	4' Drum Ground Wire	3:1 / 7:1 / 746
6703-02-020	Unit Ground Wire	3:1 / 7:1 / 746
6706-2-1	Grease, Resin Pump	3:1 / 7:1 / 746
HA-0224-25	Hose Assembly, 25'	3:1 / 7:1 / 746
HA-0344-25	Hose Assembly, 25'	3:1 / 7:1 / 746
HAW-046J6J-5	5' Airless Hose	746
HC-0224-25	Hose Assembly	3:1 / 7:1 / 746
HFL-046J6J-5	Whip Hose	3:1 / 7:1
HFL-0888-20	Fluid Hose Assmby	3:1 / 7:1 / 746
MS-2050-PAT	Catalyst Jug Assembly	3:1 / 7:1 / 746
PAT-MA-4	Air Manifold	3:1 / 7:1 / 746
PAT-CM-3A	Catalyst Manifold	3:1 / 7:1 / 746
PAT-SC-5000C-08	Surge Chamber / Filter	3:1 / 7:1 / 746
PAT-SV-1	Patriot Safety Valve	3:1 / 7:1 / 746
PAT-SWA-1000	Suction Wand Assembly	3:1 / 7:1 / 746

Catalyst Pump		
Part Number	Description	Application
PAT-CP-0980-S	Base Pump For Systems	3:1 / 7:1 / 746
PAT-CP-0980-SK	Seal Kit	3:1 / 7:1 / 746

Air Motors		
Part Number	Description	Application
PAT-PH-3250	Patriot Power Head 3.25"	3:1
PAT-PH-5000	Patriot Power Head 5"	7:1
PAT-PH-7000-HD	Patriot Power Head 7"	746

Fluid Section		
Part Number	Description	Application
PAT-LS-24050	Fluid Section	3:1 / 7:1
PAT-LS-24050-HD	Fluid Section	746
PAT-LS-OIL	Patriot Lower Section Oil	3:1 / 7:1 / 746

Slave Drives		
Part Number	Description	Application
PAT-SD-3100	Base Slave Drive	3:1 / 7:1 / 746

Guns		
Part Number	Description	Application
ATG-6500-FIT-W	Wetout Gun w/ Signal	3:1 / 7:1 / 746
AT-EXT-SK	Seal Kit	3:1 / 7:1 / 746
ATC-40323-BT	Gun Tools	7:1 / 746

Choppers		
Part Number	Description	Application
RC-1000-ATC-F	Chopper For ATC FIT	3:1 / 7:1
RC-1017	Blades, Box of 100	3:1 / 7:1
RC-1021W	Anvil Sleeve, White	3:1 / 7:1

Warranty

Product Warranty

Seller warrants that all Goods sold shall mechanically operate as specified and shall be free from faults in respect to materials and workmanship for a period of: (i) for parts, twelve (12) months from the date of invoice, and (ii) for systems, twelve (12) months from start-up, or, if earlier, eighteen (18) months from the date of the bill of lading. Seller also warrants that the Goods shall, upon payment in full by Buyer for the Goods, be free and clear of any security interests or liens. Buyer's exclusive remedy for breach of such warranties shall be limited to repair or replacement costs or termination of any security interests or liens, and Seller shall have no responsibility for reimbursing repair costs incurred by Buyer in connection with Goods without first giving written authorization for such charges. In any claims by the Buyer against the Seller in respect of the Goods, the liability of the Seller shall be limited to the value of the Goods. This warranty applies only to Goods properly used and maintained and does not apply to any Goods which are misused or neglected, or which has been installed, operated, repaired, altered or modified other than in accordance with instructions or written authorization by Seller. This warranty does not apply to any Goods not manufactured by Seller, and Buyer's sole warranty with respect to such Goods shall be that of the Seller's Vendor, if any.

Vendor Warranty

Seller shall assign to Buyer any Vendor warranties and/or remedies provided to Seller by its Vendor.

Intellectual Property Infringement

Seller disclaims any and all warranties and/or indemnifications against infringement of any intellectual property rights of any nature. Seller shall, if given prompt notice by buyer of any claim of intellectual property infringement with respect to any goods sold hereunder, request the applicable vendor to grant for the buyer such warranty or indemnity rights as such vendor may customarily give with respect to such goods.

Limitations

There are no other warranties written or oral, express, implied or by statute. Seller specifically disclaims all implied warranties of merchantability or fitness for a particular purpose. No repair of goods or other costs are assumed by seller unless agreed to, in advance, in writing.

Limitations of Liability

Unless applicable law otherwise requires, seller's and any vendor's total liability to buyer, buyer's customers or to any other person, relating to any purchases governed by these terms & conditions, from the use of the goods furnished or from any advice, information or assistance provided by seller (by any method, including a web site), is limited to the price of the goods giving rise to the claim. Neither seller nor its vendors shall be liable for any special, incidental, direct, consequential or penal damages, including, but not limited to back-charges, labor costs, costs of removal, replacement, testing or installation, loss of efficiency, loss of profits or revenues, loss of use of the goods or any associated goods, damage to associated goods, lateness or delays in delivery, unavailability of goods, cost of capital, cost of substitute goods, facilities or services, downtime, or claims from buyer's customers or other parties. If seller furnishes buyer with advice or other assistance which concerns any goods supplied hereunder, or any system or equipment in which any such goods may be installed, and which is not required pursuant to these terms & conditions, the furnishing of such advice or assistance will not subject seller to any liability, whether based on contract, warranty, tort (including negligence) or other grounds.

Warranty and Exceptions

Because of the variety of electrical codes in various parts of the world, MVP does not supply connections to any of the heaters mentioned in this manual. The electrical connection should be made by a qualified electrician per codes of local jurisdiction.

Contact



North America

www.mvpind.com

info@mvpind.com

Phone: 1-865-686-5670

Corporate Headquarters

2400 Cherahala Blvd, Knoxville, TN
37932 · USA

Manufacturing Operations

1862 Ives Ave.
Kent, WA 98032

International Technical Service

Phone: +1.253.854.2660 ext 4520

Email: dsmith@mvpind.com

International Closed Mold Support

E-mail: charlestur@hotmail.com

China

Distributor: [MVP Hong Kong-China](#)

Phone: (025) 8664.7550

France

Distributor: [Matrasur Composites](#)

Phone: 33.(0) 1.61.61.65.65

India

Distributor: [MVP-India](#)

Phone: 91.85.888.741

Italy

Distributor: [MVP-Italia](#)

Phone: 39.02.484.01180

Japan

Distributor: [F.R.P. Services & Company](#)

Phone: 81.422.49.7961

Netherlands

Distributor: [CT Platon B.V.](#)

Phone: 00.31.183.505548

Poland

Distributor: [MVP-Polska](#)

Phone: 48.22.812.74.36

Spain /Portugal

Distributor: [MVP-Espana](#)

Phone: 34.913.788.480

United Kingdom

Distributor: [MVP-Europe](#)

Phone: 44.01384.486222

United Arab Emirates, Qatar, Baahrain, Saudi Arabia

Distributor: [MVP-Middle East](#)

Phone: 971.653.14999